

**THE**

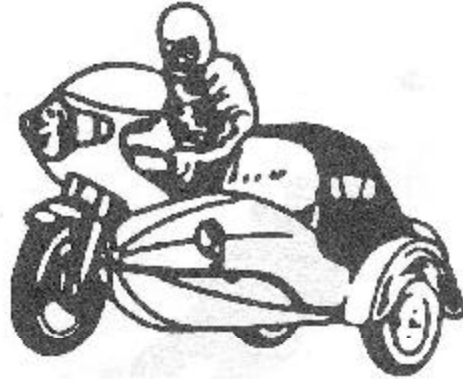

**SIDECAR**

**OPERATOR**

**MANUAL**

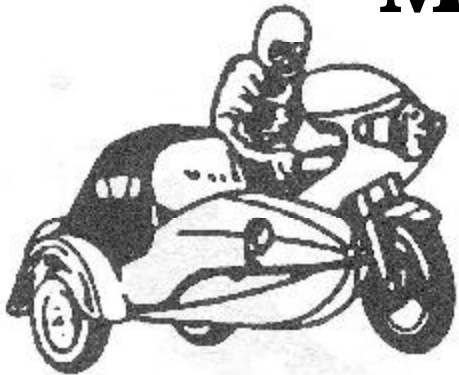

**2003.**

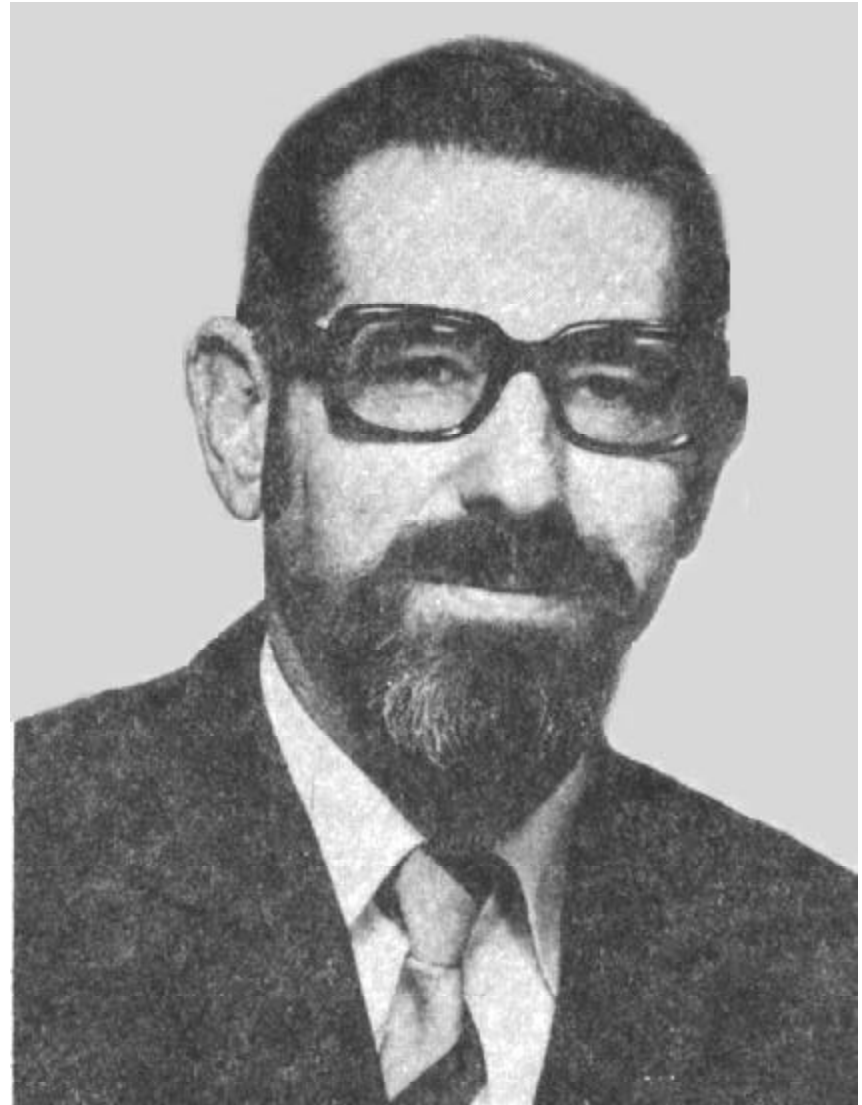

Hal Kendall - Author

Hal built his first sidecar outfit in 1953 in Melbourne, Australia. He has built and driven many outfits in Australia, the US, and the UK

# PREFACE

You have just acquired a motorcycle-sidecar combination. Being neither a solo motorcycle nor a motorcar, its control is partly dictated by motorcycle operation and partly by the behavior of a two-tracked vehicle. Special skills are required which are taught neither by a solo motorcycle rider course nor by an automobile education driver course. These skills and exercises are not difficult to master. They have been defined herein by the United Sidecar Association, Inc. (USCA).

Any motorcycle operator can become proficient in sidecaring skills once he realizes the differences a two-track vehicle requires. Similarly, any automobile or truck operator can develop these skills once he becomes familiar with motorcycle controls. In fact, a person without any riding skills can often master driving a sidecar outfit far more readily than a solo motorcycle or an automobile.

The purpose of this manual is to develop the necessary driving skills required by a sidecarist. In researching these materials, the author has utilized reference materials supplied by the National Highway Traffic Safety Administration, the Motorcycle Safety Foundation, the American Motorcyclist Association, and the Motorcycle Industry Council.

It is hoped this manual will find ready use by motorcycle skill schools, State Departments of Motor Vehicles, Departments of Public Safety, and by all new sidecarists everywhere.

Many have turned to the sidecar as a low cost, energy efficient family unit alternate to a small car. When driven within its performance limits, its safety record rivals that of any other form of transportation.

Doug Bingham, Former President, United Sidecar Association, Inc.

H. A. Kendall, Ph. D., Co-Founder, Past President, and psdt Executive Secretary, USCA, Inc.

## ACKNOWLEDGEMENTS (1st Edition)

The author gratefully acknowledges the encouragement of the membership of the United Sidecar Association, Inc., and the support of the Executive Committee. This manual is the outgrowth of their needs.

The author acknowledges Dr. James McKnight, President of the National Public Safety Services Research Institute, Gary Winn of the American Motorcyclist Association, and, Dr. Elizabeth Weaver of the Motorcycle Safety Foundation, who reviewed the draft manuscript. Their constructive suggestions enhanced the utility of the manual. Lewis Buchanan of the National Highway Transportation Safety Administration provided additional guidance.

Credit is due to Dale McCormack and Tim Colburn of the Motorcycle Safety Program, Northeastern Illinois University, and to Dorde Woodruff, USCA Editor, for reviewing the manuscript and advising suggestions in the material content. Al Johnson supplied most of the photographs while Joe Ruthford created the artwork.

Also, to Lee Kendall, the patient wife, full credit for preparing the numerous drafts, and to Martha Barnes for preparing and revising the final copy several times.

The United Sidecar Association, Inc., is a non-profit organization, created to serve sidecarists in America.

The Association is supported by sidecarists, sidecar manufacturers, and by friends of sidecarists. It serves sidecarists as the AMA, the MSF, and the MIC serve the motorcyclist-at-large.

### Update

This manual has been updated at the request of persons new to sidecarring. It includes appropriate segments from Kendall's other writings, and also the 2nd and 4th edition of the BVDM's "Riding with a Sidecar"

Hal Kendall

# CONTENTS

## PREFACE

## CONTRIBUTIONS

## ACKNOWLEDGEMENTS

### 1. PREPARING TO RIDE

Personal Protective Equipment -- Helmet -- Eye and Face Protection -- Outerwear

### INSPECTION OF THE SIDECAR OUTFIT

Tires -- Wheels and Bearings -- Front End -- Sidecar Fittings and Installation -- Springing -- Controls -- Brakes -- Clutch, Throttle, and Transmission -- Lights -- Headlight Flasher -- Signals -- Brake Light -- Horn -- Chain -- Chain Breakage -- Mirrors -- Fuel and Oil -- Familiarization

### CONTROL POSITION FOR SAFETY

Body Positioning -- Hands -- Feet -- Knees -- Posture -- Turning -- Turning Toward The Sidecar -- Turning Away From The Sidecar -- Braking -- Quick Stops -- Avoiding Obstacles -- Changing Gears -- Shifting In A Turn -- Starting On A hill

### BEING PERCEIVED

Headlight -- Conspicuity (Visiblensess) -- Position In Traffic

### LOOK FOR TROUBLE SITUATIONS

Head Checks -- Using Your Mirrors -- Positioning

### KEEPING YOUR CUSHION

Following Distance -- Distance To The Side -- Intersections -- Parked Cars -- Sharing Lanes -- Merging Cars -- Cars Alongside -- Distance Behind

### HANDLING UNUSUAL SURFACES

Uneven Surfaces -- Riding Over Objects -- Grooves and Gratings -- Sloping Surfaces

### NIGHT RIDING

### EMERGENCIES

Avoiding Obstacles -- Minor Emergencies -- Flying Objects -- Animals

### MECHANICAL FAILURES

Blowouts -- Stuck Throttle -- Wobble

Engine Seizure -- Getting Off The Pavement

### CARRYING PASSENGERS/CARGO & BALLAST

### TRAILERS

### GROUP RIDING

### OPERATOR PHYSICAL/MENTAL CONDITION

### MOTORCYCLE/SIDECAR OUTFIT

The Necessary Equipment -- Sidecar Care

SIDECAR OPERATOR MANUAL

SIDECAR OPERATOR SKILL TEST

Starting On A Hill

Sharp Turn, Turning, And Stopping

Turning Speed Judgment

Quick Stop - Straight

Quick Turn

Quick Stop - Curve

Stopping The Test

U S SIDECAR MANUFACTURERS/DISTRIBUTORS

ABOUT THE USCA

ABOUT THE AUTHOR

## ABOUT THE AUTHOR

The sidecar operator manual was compiled and edited by Hal Kendall, Ph.D., of Houston, Texas.

Kendall is the co-founder and executive secretary of the United Sidecar Association, Inc. He is also the founder of the International Laverda Owner's Club, and the co-founder, executive secretary, and president pro-tem of the Association Of Jensen Owners.

Hal's association with sidecars spans a half a century. He is a dedicated champion of issues related to motorcycle safety, of bikers rights, and on equality on the nation's tollways for sidecarists. His numerous articles and manuals on sidecaring have been published in England, Australia, and the United States.

Professionally, Hal is currently responsible for training drilling personnel of a major international drilling contractor. His prior activities include working variously for several major international integrated oil companies as a senior research drilling technologist, associate drilling engineer, chief drilling engineer, country operations manager, and chief logistics engineer.

Academically, Hal began with a Bachelor of Civil Engineering w/ Honours from the University of Western Australia, a M.Sc and Ph.D from the Texas A&M University, and a M.Lit. in Natural Science from the University of Pittsburgh, PA.

# 1. PREPARING TO RIDE

The sidecar operator is nearly as vulnerable to injury as is the solo motorcycle rider. For their well being both should dress appropriately and check the mechanical condition of the vehicle carefully.

## Personal Protective Equipment

### Helmet

The University of Southern California motorcycle accident study showed that helmets afford motorcycle riders and passengers a high degree of protection from head and neck injuries at all levels of severity.

Helmeted motorcyclists are much less likely than unhelmeted ones to suffer head injuries at all. Injuries which do occur are less severe, and less likely to be fatal.

Helmets provide a high degree of safety at the speeds at which motorcycle accidents typically occur. However, a helmet may not offer sufficient protection under certain accident conditions, such as when a solid object is impacted at a right angle rather than tangentially.

Also, injuries to other parts of the body such as the chest can be severe or fatal. Prevention of accidents remains a most important goal. Proven driving skills, a developed "road sense", and conspicuity (visibleness) are significant factors in reducing your chances of an accident occurring.

## 1. PREPARING TO RIDE

Sidecars are under-represented in motorcycle accident occurrences and data. The author's experience is that the sidecarist is less likely to part company from his vehicle than the solo motorcyclist, who typically flies over the handlebars and may hit an oncoming vehicle with his head. When forced to separate from his machine, the author has always rolled and remained uninjured.

However, there is no guarantee that a sidecarist will not hit his head during an accident. A well-fitting DOT-approved helmet should be worn at all times. Reflectolization is sometimes a legal requirement and adds to conspicuity of the wearer. For the same reason, white or light or bright colors are best. Helmets should be used in conjunction with eye protection. A helmet with a damaged shell should be replaced. Those which have been impacted while being worn should be inspected by the manufacturer for hidden damage to the energy-absorbing liner. If the shell is intact, it may be possible for a helmet to be repaired; at least one manufacturer (Bell) has a complete service. Older helmets though not damaged or deteriorated may not provide the degree of protection offered by newer designs.

Helmets should be well fitted and obtained from approved helmet manufacturers only. Be ware of cheap helmets which may not protect you when needed. A Y strap has superior holding to a single point. A full face offers more protection than a 3/4 face which is superior to a 1/2 cap.

## SIDECAR OPERATOR MANUAL

### Eye and Face Protection

The sidecar operator is exposed to weather, highway debris, insects, and dirt. Unlike the helmet, which offers protection only to its wearer, eye protection also protects the public-at-large.

Should the operator become temporarily blinded, all road users in the vicinity could become at risk. Even when no foreign body enters the eyes, the continuous drying action of the wind can seriously impair vision by creating dehydration and chemical imbalance. In many States, eye protection is a legal requirement; where not required by law it is good sense to use it.

Eye and facial protection comes in many forms including: windshield, goggles, a face shield, and safety prescription spectacles. With a proper helmet the probability of spectacles flying off is surely reduced.

If goggles are used, the elastic strap should go on the inside of the helmet if comfortable. Eye protection should be free of scratches; be constructed of shatterproof material; offer unobstructed sideview; be securely fastened; allow proper ventilation to prevent fogging; and, allow room for goggles or glasses. Tinted lenses, goggles, or shields are useful, but are for daytime use only.

### Outerwear

Protective clothing should be worn at all times. The type of clothing used depends on the type of

## 1. PREPARING TO RIDE

riding anticipated. It should be comfortable and designed for the conditions expected.

Protective clothing can include nylon, denim, or leather jackets and riding pants, and boots and gloves. Kidney belts may reduce fatigue during long distance touring.

All clothing should be designed to fit snugly but without restricting movement. The best visibility is afforded when bright colors are selected. Lime-yellow is the most conspicuous. Special attention should be given to protection of feet and hands which can become numb if not properly protected. Heavy leather products and strong synthetic materials can provide adequate protection. Boots are definitely recommended for safe sidecar operation.

The sidecar operator can have much more protection from the elements than can a solo operator. Frame mounted full fairings can provide considerable protection from the elements for the entire body. In addition, as the sidecar operator becomes more a part of his machine than does the solo operator, he can use protective riding chaps fitted to his machine that cover his entire body, including his feet, leaving only the upper shoulders and arms exposed. These chaps are not as useful for the soloist as he must remove his feet for balance every time he stops. The operator, once astride, pulls the chaps around himself for nearly complete protection from the elements yet without any reduction in his control of his machine.

## Helmet Fit - Courtesy of Bell Helmets

### Six Key Steps In Determining Proper Helmet Fit.

- Measurement -- Try-on -- Horizontal and Vertical Movement Check -- Retention Check -- Pressure Point Check -- Confirming Proper Fit

#### 1. Measurement

Measuring the head is a starting point for the entire sizing procedure. Due to varying shapes, heads that are apparently the same size when measured by a tape may not necessarily fit the same size helmet.

A small metal tape measure, or a cloth tape may be used to make your initial measurement. The circumference of the head should be measured at a point approximately one inch above the eye-brows in front, and at a point in the back of the head that results in the largest possible measurement. Take several measurements, to make sure you have the largest one.

#### Size Cross Reference

##### Adult sizing

X-Small: 6-3/4" Small: 7"; Medium: 7-1/4"

Large: 7-1/2" X-Large: 7-3/4"

#### Head Circumference

21			22		23		24		25
6 5/8	6 3/4	6 7/8	7	7 1/8	7 1/4	7 3/8	7 1/2	7 5/8	7 3/4
X-Small			Small		Medium		Large		X-Large

## 1. PREPARING TO RIDE

### Children Sizing

Small: 50cm; Medium: 52cm:

Large: 54cm X-Large: 56cm

#### 2. Try-On

Once you've determined your preliminary tape measurement, select the helmet that is closest in hat size to the tape measurement. If it is between sizes, round-up to the next largest size. Now try on your helmet.

If you are not familiar with helmets, you should use these instructions on the proper procedure for putting one on:

- A. Grasp the helmet by the chin straps, with the front of the helmet facing you and the top of the helmet facing down.
- B. Place your thumbs on the inside surface of the straps and balance the helmet with your index fingers.
- C. Spread the helmet apart with your hands, and slip it down over your head.

## SIDECAR OPERATOR MANUAL

Helmets of different shapes go on differently. Sometimes, the front of the helmet must go on first; other times, the rear.

If the helmet flops down on your head with no resistance, you have your first indication that it may be too large.

Obviously, if it won't slide down over your head at all, it is too small.

Many people unfamiliar with helmets are reluctant to pull down if they meet resistance as the helmet goes on. To tell if it is really too small, or just snug going on you should continue the effort to get the helmet on. Only if the helmet is impossible to put on should you move up to the next size, as helmets that go on snug generally fit very well once on all the way.

Remember, most people will select a helmet that is too large for them. They will regret it later, because ill-fitting helmets are more likely to be noisy, windy and fatiguing to wear.

We have noted that some people have a tendency to wear a helmet perched on the backs of their heads, like hats. Be sure that the helmet is sitting squarely on your head. Use the location of the eyes in the eyeport of a full face model as a gauge.

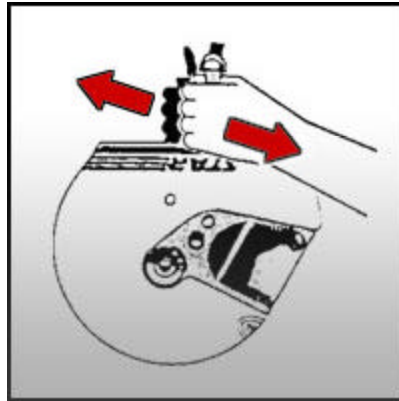

### 1. PREPARING TO RIDE

The eyes should be approximately in the center, with the top edge of the liner padding just above the eyebrows.

### 3. Checking Horizontal and Vertical Movement

Now that you are wearing the helmet, use a mirror to look carefully at the way it fits. Check to see if the cheek pads are in contact with the cheeks. Is there excess pressure on the cheeks?

Look for gaps between the temples and the brow pad.

Check the back of the helmet where the neck roll (if the helmet has one) makes contact with the neck. Does it touch at all? Or is it pushing the helmet away at the rear, causing it to roll down over the eyes in front?

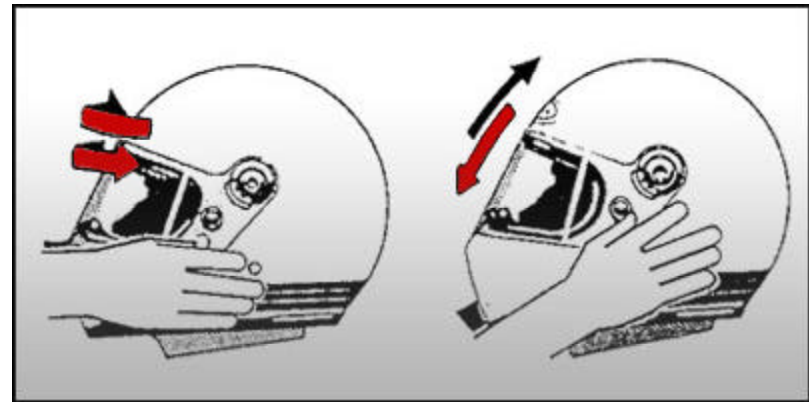

## SIDECAR OPERATOR MANUAL

After you have made your visual check, grab the helmet in your hands - one on either side - and try to rotate the helmet from side-to-side. Note any movement of the skin while doing this, as well as the amount of resistance to movement. Hold your head steady to do this.

Next check movement up and down, again noting skin movement and resistance. If in either test there was little or no skin movement, and/or the helmet moved very easily, the helmet is too large.

It is important to note here that you should think about the comfort of the helmet during the fitting process - with respect to comfort, pressure points, or anything else that will help you make the right sizing choice.

A properly fitted helmet will cause the skin to move as the helmet moves. And, it will feel to the wearer as if evenly distributed pressure is being continuously exerted around the head.

NOTE: Helmets are a little like shoes, in that they do break in a little. For this reason, the best attitude to have when fitting is that the helmet should be as tight fitting as you can stand to wear it - taking into consideration the length of time it will be worn.

For Example: A drag racer's helmet can be very tight, because it will only be worn for a few minutes at a time. On the other hand, a police officer, who wears a helmet for hours at a time is more concerned with comfort.

## 1. PREPARING TO RIDE

### 4. Retention Check

Now fasten the chin strap, so you can check it. After the strap has been tightly fastened, hold your head steady, and note that this test may be a little uncomfortable, but that it is very important. Reach over the top of the helmet, grabbing the bottom edge with your fingers. Then try to roll the helmet off your head. If it comes off, it is undoubtedly too large.

NOTE: Do not use a helmet that can be rolled off the head with the strap fastened! Try not to cause severe pain, but do give a good, strong pull on the helmet. THIS TEST IS VERY IMPORTANT.

### 5. Pressure Point Check

Finally, unfasten the chin strap and remove the helmet. Immediately after the helmet has been removed, use a mirror to observe the coloration of the skin on the forehead and cheeks.

A reddening of the skin in a small area may indicate a pressure point. Pressure points sometimes are not noticed by the wearer until after several minutes, or even hours of wear. They sometimes cause headaches and are, at the least, uncomfortable. If you notice a pressure point, note if you experienced discomfort in that area while wearing the helmet. If you can't remember, put the helmet back on for a few minutes, paying particular attention to the anticipated pressure point(s). If the pressure point discomfort contin-

## SIDECAR OPERATOR MANUAL

ues, go to the next largest size, repeating steps three, four and five.

### 6. Confirming Proper Fit

One way to confirm your evaluation of proper fit is to try on helmets that are one size larger and one size smaller than the one you think is right. Keep in mind that people gravitate towards larger sizes.

Another way, is to wear the helmet around the store for a few minutes. This will allow any pressure points to show up.

**WARNING:** No helmet can protect the user from all foreseeable impacts. For maximum protection, a helmet must fit securely and should provide adequate peripheral vision. The chin strap must be securely fastened.

Questions or Comments? Email Bell at:  
[bellhelmets@earthlink.net](mailto:bellhelmets@earthlink.net)

## 1. PREPARING TO RIDE



Bell Full Face M-5,  
Blue Multi



Bell Open Full Face  
Tourlite Silver



Bell Shorty  
Flames

Check with your helmet dealer re options, specifications, and accessories.



Proper Riding Attire - Model lost her gloves!

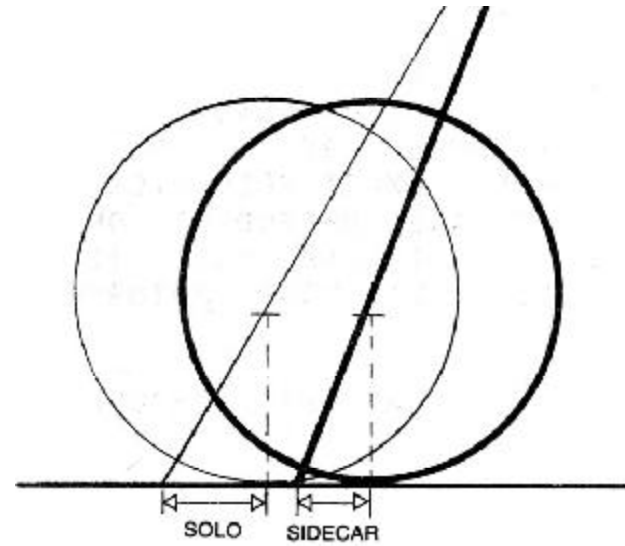

Ideal Trail for Solo and a SC Rib

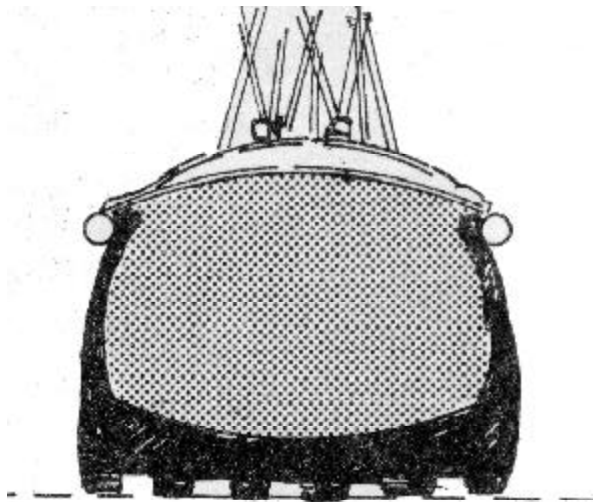

Ideal Rear Tire Profile for a SC Rig

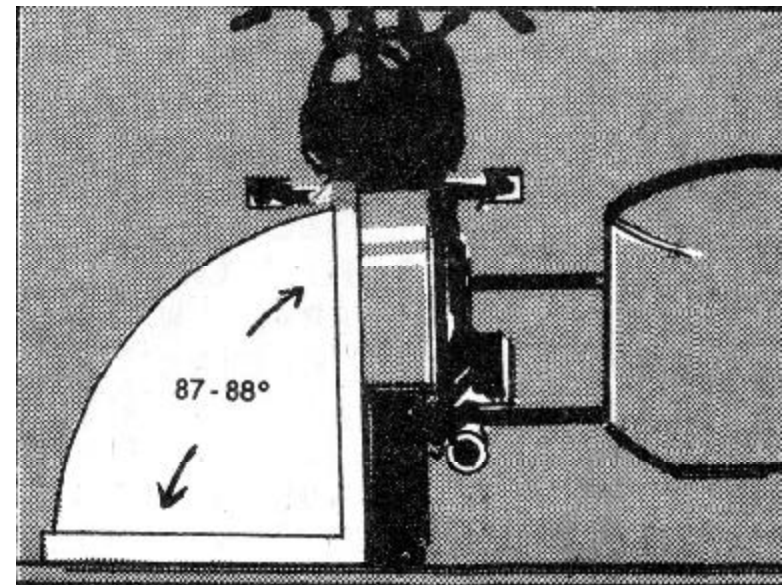

Lean-out should be 1 to 2 degrees, unladen

## INSPECTION OF THE SIDECAR OUTFIT

A sidecar outfit requires all the checks of a solo machine plus a few unique to an outfit. Your chances of enjoying the ride are greater when all components are in good working order. Here are some of the more important checks.

### Tires

All tires, front, rear, and sidecar, should be checked for correct inflation pressure (see owners manual for recommendations). Since the added sidecar weight affects all wheels, slightly higher pressures (within manufacturer's limits) should be used. Under-inflation can cause serious sidewall deterioration and increase the risk of tearing the tube valve loose during severe acceleration (rear), or during severe braking (front or rear).

Tires for sidecar operation must have strong yet flexible sidewalls to keep as much tread in contact with the road surface, even when they are subject to heavy cornering forces. In this respect, tires developed for solo use, with a rigid sidewall and a rounded or "V" tread profile, are unsuitable for sidecar operation. Tread profile should be as flat as possible.

Radial tires are just as desirable for a sidecar outfit as they are for auto use. Radials, if fitted, should NOT be used if the sidecar is removed.

## 2. INSPECTION OF THE SIDECAR OUTFIT

Check sidewalls and tread for cracks, cuts, blemishes, and foreign objects. A blowout of any one of the three tires is less likely to result in loss of vehicle control except under the most adverse conditions.

Because of its asymmetrical design, the sidecar outfit has been fitted with all shapes and sizes of tires. The only reason to have a set of identical wheels and tires is if you have an outfit set up with quickly detachable, QD, wheels that could be mounted at any corner and you also carry a spare. Otherwise, select each tire for its specific purpose at each corner.

Nonetheless, it is false economy and dangerous to operate a machine with weak or balding tires, or with air-rotted sidewalls. Tires can and have blown out. Patched tires can be very unreliable.

### Wheels and Bearings

Some motorcycle wheels of light pressed steel or thin spoke construction may not endure the high cornering loads imposed by sidecar operation without considerable flexing, or breaking of spokes. In this case they should be replaced or respoked. Heavy-duty spokes prevent breakage from reoccurring. Inspect spoke tightness frequently.

Each should be of uniform tightness. The wheel should be both true and balanced. Wheel bearings are usually designed to handle vertical loads,

## SIDECAR OPERATOR MANUAL

but not side loads. The addition of a sidecar creates large side-loading forces when turning.

Attention should be given to lubricating wheel bearings more often than required for solo operation. If possible, adjustable tapered or pre-loaded tapered bearings should be used in place of conventional wheel bearings.

### Front End

Some sidecar outfits may exhibit a tendency to shake the handlebar or wobble at low speeds, especially when decelerating. Often the cause can be traced to out-of-round or out-of-balance tires or wheels, worn bearings in the axle, steering head, or rear swinging arm; or worn swing arm bearings. Or it could be due to mount flexing between the sidecar and the motorcycle or play in the connections themselves. The cause should be located and remedied, if possible. Low speed wobble, if it persists, can often be reduced or eliminated by adding a friction or hydraulic steering damper.

A word of caution. All dampers have a stiction factor. The stiction force must be overcome before any steering effort is turned into turning the handlebars. The stiction force can be easily adjusted for a friction damper but not for a hydraulic damper. A high stiction force means that the steering will become somewhat wooden. You put force to turn and nothing happens. You are re-

## 2. INSPECTION OF THE SIDECAR OUTFIT

sisted by the stiction force. So you must put more force into the turn. Then, when you want to straighten out you relax the bars and nothing happens. Again, the stiction force. Instead of the self-centering force straightening the rig out you must turn the bars back to straight coming out of the turn. Again, the stiction force. If too great with a friction damper, just back off on the amount of friction. Just be sure that if you feel you must use a damper you do not have too strong a damper.

Heavy cornering effort often results when a sidecar is added because of the large trail employed by contemporary motorcycles. Reduction of trail to about 2 inches will result in much easier handling. Trail can be reduced in several ways.

Haley-Davidson offers an adjustable trail. In others the triple tree can be modified. One of the best set-ups for sidecar operation is a leading link system which increases the lateral stability of the forks. Triple tree modification should only be done by an expert.

Adding a forkbrace is another way to reduce the tendency for a sidecar rig to wobble. Also, fitting larger diameter sliders will increase the lateral rigidity and reduce the tendency to wobble. Ensure that the forkbrace is fitted correctly or else this can cause the forks to stick/

## SIDECAR OPERATOR MANUAL

### Sidecar Fittings and Installation

Care must be given to fitting the sidecar to the machine. All mountings must be made to the primary motorcycle frame. Rigid connections are preferred because flexing at any mounting point can result in steering wobbles or other handling problems.

It is extremely important that the outfit be properly aligned. An ill prepared machine can be very tiresome to operate.

When the machine is properly set up it should enable the operator to drive 30 mph on a flat surface without the machine pulling in either direction.

To achieve this, the sidecar wheel should be toed-in about 0.25 to 0.75 inches, the motorcycle should also lean outward 1 to 2 degrees and the sidecar wheel should lead the rear wheel by 6 to 10 inches. Exact specifications dependent on which sidecar unit is fitted onto your motorcycle.

Leaning the bike outwards slightly causes the bike to want to turn naturally to the left which partially offsets the drag of the sidecar to the right. It also lifts the center of gravity slightly by making the weight on the sidecar wheel a little lighter.

Toeing the sidecar wheel in slightly also tends to cause the rig to turn just a little to the left which further aids the tendency of the sidecar drag to the right.

## 2. INSPECTION OF THE SIDECAR OUTFIT

Moving the sidecar wheel forwards tends to make the bike less susceptible to tipping over the tip-over line between the front wheel and the sidecar wheel. However, it also requires more steering effort as the sidecar wheel now drags. If moved too far forward the sidecar wheel may pivot or turn backwards when turning sharply to the right.

It is interesting as the original sidecars were set-up with zero leanout, zero sidecar wheel lead, and zero toein. The current settings are based on driving practice as rigs became heavier, more powerful, and faster.

Sidecar weight should also be matched to the machine. The sidecar will be lifted very easily on sharp turns toward the sidecar if it's too light. If too heavy, overall performance will suffer considerably; also the effect of the sidecar, to lag behind on acceleration and to swing around on hard braking, will be accentuated. Typically, a sidecar that weighs about 30 percent of the weight of the bike seems to be about right. If too light, adding some weight, ballast, to the sidecar, car battery, weight, fuel tank, water tank, will aid greatly to the stability of the outfit.

### Springing

A motorcycle-sidecar outfit is designed to carry far more load than a solo machine. Light springing and weak damping will cause considerable

## SIDECAR OPERATOR MANUAL

roll, especially on cornering. Best results will be obtained by using firm yet not harsh suspension on all three wheels. If suspension is too soft, the outfit will roll to the direction opposite the turn just as with any two-track vehicle, unless a stabilizer is fitted.

The passenger can have a very comfortable car-like ride in the sidecar if the body is sprung independently from the frame, especially if the degree of movement is also damped. This can often be done as an aftermarket modification

## Controls

### Brakes

Braking systems vary considerably from outfit to outfit. Some have an integrated front and rear braking system. Others have an integrated rear wheel and sidecar wheel braking system. Some sidecar wheels have no braking system.

Others have a sidecar wheel that can be independently braked either by a separate foot pedal or from a separate handlebar control.

Regardless, the primary braking system continues to be that of the motorcycle itself. If a sidecar brake is used that is integrated with the rear wheel, it should be adjusted to become effective slightly after the rear brake has begun to act.

Hydraulic brakes allow for the force to be split, 65 percent for the rear wheel, 35 percent for the

## 2. INSPECTION OF THE SIDECAR OUTFIT

sidecar wheel. ABS systems are coming down in price and may soon be found on sidecar rigs.

Brakes should always be tested thoroughly before each journey. Not only should they stop the vehicle well, but also linings or pads should be in good condition. When checking the brakes, test the rig with the sidecar empty, the sidecar loaded, and with a rear passenger. You would be very surprised that the difference it makes on braking just where the load is placed.

Drums and caliper discs should always be kept in good condition. Periodic checks should be made to the level and condition of the hydraulic fluid, the hydraulic lines and fittings, and to any mechanical linkages or cables.

Your life depends on brakes that will operate whenever you apply them. Brakes should work smoothly and effectively in both dry and wet weather.

### Clutch, Throttle, and Transmission

The clutch, throttle, and transmission controls enable the operator to achieve desired speeds. Because of the additional weight of the sidecar, the operator will find these controls are used more often than during solo operation. The correct gear must be used so that the engine is never overly stressed. It must be neither over-revved nor lugged. The clutch lever and controls whether

## SIDECAR OPERATOR MANUAL

cable operated or hydraulically activated, must be smooth in operation without sticking or binding.

Likewise the throttle must be smooth in operation. Inner cables should be checked for broken strands, and casings for breaks or damage. Many experienced riders tape a spare cable onto the operating cable; this provides a ready replacement should the cable break. If the throttle cable should break, the engine should be turned off and the machine brought to a stop. Makeshift operation with a broken throttle cable or clutch cable is unsafe.

### Lights

Lighting enables an operator to see where he is going at night and allows others to see the vehicle. Because you have a wide, visible vehicle, daytime conspicuity is enhanced over that of a solo machine. However, due to low sidecar height, it may be obscured by that of traffic behind it.

Some additional lighting for nighttime operation is desirable, such as running lights on the front and rear to delineate sidecar width. Other lights may be useful, such as an amber turn signal light on both the right front and right rear of the sidecar. The turn signal lights on the motorcycle between the motorcycle and the sidecar should be rendered inoperative. An additional stop light on the sidecar is also recommended. When the sidecar is fitted the sidecar stoplight should be connected to the rear

## 2. INSPECTION OF THE SIDECAR OUTFIT

stop light of the motorcycle, and both lights activated when either front or rear brake is used.

It is extremely important that the electrical system function reliably and effectively. This includes the battery and the charging system. If voltage is allowed to become excessive all light bulbs will prematurely burn out and the battery will fail. If charging voltage is insufficient the battery will discharge. Some older motorcycles and a few in current production, have balanced charging systems not designed for continuous headlight use. The daytime headlight use requirement in some States does not consider this problem.

It may be necessary to recharge the battery externally, or to alter your driving habits by driving in lower gears to maintain sufficient engine speed to keep the battery charged.

Care must be taken when fitting an additional headlight to determine that it does not overload the electrical system. If a headlight on the sidecar is required by State law and your charging system is marginal, lower wattage headlights may be used. An additional driving light on the sidecar is desirable if the electrical system has a high power output.

Check that all lights installed comply with vehicular codes, are approved, and are operational.

### Headlight Flasher

Some motorcycles are fitted with a flasher that operates the high beam of the headlight when the

## SIDECAR OPERATOR MANUAL

flasher control is depressed. This feature can be used to warn other road users of your presence. It may be flashed rapidly, or held on, depending upon circumstances. However, the headlight should not be flashed indiscriminately. Its ability to attract attention is more effective in States without mandatory daytime headlight laws than in States which require continued headlight operation; the effect of the flashed high beam is masked when the low beam is already on.

The operator should never rely solely upon continuous or flashing light for protection. In those states that now require daytime headlight operation, intersection accidents still continue at about the same rate as previously.

### Signals

All road users are expected to communicate intended directional changes by visual signals before either changing lanes or turning. Illuminated turn-signal indicators are usually more effective than hand signals, providing added conspicuity. They should be used even if the intended action is obvious, such as when entering or leaving a freeway system, or when turning right or left into a T-junction. Since few motorcycle turn-signal indicators are self-cancelling, it is equally important to remember to cancel them manually, after executing the intended maneuver.

## 2. INSPECTION OF THE SIDECAR OUTFIT

Most motorcycles are equipped with turn-signal equipment on both sides of the machine, facing forward and rearward. Using the turn-signal indicators on the side between the motorcycle and the sidecar can be quite confusing to other road users, and they should be disconnected. The sidecar turn signal indicators should be on the outermost side.

Note: Some states, Nevada for example, require that you keep both hands on the handlebar at all times.

### Brake Light

The brake lights on a motorcycle-sidecar outfit can be made just as conspicuous as brake lights on a car.

Given the full width of the sidecar body, one or more stop lights can be fitted so that their meaning is quite unmistakable. Even so, it is good form to tap (or "blink") your brake if intending to slow down; if you see congestion ahead; if a tail-gater insists on crowding you; or, if you plan to slow down or turn at a place at which others may not expect you to do so.

### Horn

The horn should be used to direct other road users to your presence. Whereas a light is effective only when another road user has eye contact with the light, an audible signal is omni-direc-

## SIDECAR OPERATOR MANUAL

tional. However, as most other road users are within a steel and glass enclosure with other, distracting sounds, such as radio, air conditioning, or heating system, the net effectiveness of motorcycle horns is reduced. The horn should emit a very strong noise. Air horns are very effective in this regard. Whatever horn is fitted, it must be functional at all times - and used whenever it is necessary for your protection. However, do not rely on making someone actually seeing you and moving out of your way.

### Chain

The added weight of a sidecar demands more from primary and final drive chains than does solo bike operation.

To obtain full life, chains must be given careful attention. They must be kept well lubricated. Tension must be adjusted so that it is neither too tight nor too loose. The latter will cause the chain to become excessively hot and stretch. The lengthening of the chain may cause it to come off the sprocket. Sprockets must be aligned so that the chain is not twisted. Any misalignment will cause the chain life to lessen much more than if used strictly as a solo bike.

Consult your owner's manual for correct chain inspection and adjustment procedures.

## 2. INSPECTION OF THE SIDECAR OUTFIT

### Chain Breakage

If the primary or the final drive chain breaks you have lost your connection between the engine and the rear wheel. Pulling in the clutch lever immediately may prevent or reduce further damage. In some cases a loose chain may have jumped the rear sprocket, causing the rear wheel to stop turning. Turn off the engine, and brake to a stop as soon as it is prudent to do so.

Chain breakage or Jumping the sprocket is generally caused by inattention to the condition of the chain or sprocket.

The chain will stretch quickly if not maintained properly. Continued use of a worn or stretched chain will rapidly wear down one or both sprockets. Likewise use of a worn sprocket will rapidly wear out a chain.

### Mirrors

Mirrors should be clean and correctly adjusted to provide a clear view of the road behind at all times. Each mirror should allow visibility of the adjacent lane, in addition to as much rearward vision as possible. Do not adjust mirrors while in motion. Some mirrors vibrate excessively. You may need a different mirror setup, or it might be that there is an engine problem that is causing the vibration and is in need of attention.

## SIDECAR OPERATOR MANUAL

### Fuel and Oil

Check fuel and oil levels before starting out. Be sure the fuel petcock is on the normal setting. When the main supply is nearly consumed, the engine will gradually lose power. Switch the petcock to the reserve position before the engine dies, to avoid draining the carburetor and, therefore, possible restarting problems.

Most motorcycles have only a small reserve fuel capacity, so fill the tank promptly. To minimize condensation water collecting in the fuel tank, it is always good practice to keep the tank full overnight, or when the machine is not being used.

Always be sure your oil level is correct and the oil is clean. Your engine will work harder with the sidecar attached, so more frequent oil changes are recommended.

Many sidecarists often add an oil cooler to keep the oil temperature to a more normal working range. If the oil level becomes too low or is lost, or if the oil pump fails, the engine will overheat and possibly seize, although generally you will experience considerable loss of power beforehand. If the engine appears to want to seize, pull in the clutch and stop. The effects of engine seizure will stop the functions of the entire drive-chain and cause the rear wheel to skid.

## 2. INSPECTION OF THE SIDECAR OUTFIT

### Familiarization

All controls, whether foot or hand operated, should be easily located by the operator, without diverting attention from the road ahead. This is especially true when operating an unfamiliar outfit. Each motorcycle control acts and responds differently. In addition to normal motorcycle controls - - brakes, throttle, clutch, gear change, headlight switch, engine cutoff switch, fuel valve, lighting switches, and horn - - the behavior of each rig while riding will likely be different.

Drive slowly and cautiously until you become very familiar with the operation of any motorcycle-sidecar outfit.

## CONTROL POSITION FOR SAFETY

A motorcycle-sldocar outfit is exceptionally stable and will not fall over like a solo machine. Even so, some basic driving tips are necessary to keep the outfit under control.

### Body Positioning

As with any vehicle, the operator's position is important in reducing or preventing fatigue. The operator should be able to reach both handlebars comfortably. More handlebar movement is necessary than when making an identical turn on a solo machine.

Although body lean will not cause the outfit to alter direction, by shifting your weight into the direction of the turn, better control of the outfit is produced. It should not be necessary for the passenger to move around. That is only for professionals in racing outfits. Also, it is not necessary for the driver to move drastically. The actual weight transference is slight. It helps a little not a lot. Never get so involved in sliding around on your saddle that you lose control or make driving tiring. Try to keep your body low as this also lowers your center of gravity, COG.

### 3. CONTROL POSITION FOR SAFETY

#### Hands

The handlebars should be gripped firmly but not tightly. Be prepared to resist any slow-speed wobble if it occurs. Do not allow the handlebars to oscillate.

If wobble becomes a problem, a steering damper should be fitted. Hands should be positioned at or near the appropriate controls ready to take whatever action may be necessary.

#### Feet

Unlike in riding solo motorcycles, there is never any need to place either foot on the ground when in motion. In fact, to do so, especially with the foot located between the motorcycle and the sldocar, is to risk severe injury.

#### Knees

During normal riding, the operator's knees should be against the gas tank. This will allow the motorcycle to pitch over rough roads while retaining control. On sharp cornering, however, more body movement can be used by pressing the knee opposite the turn against the tank and relaxing pressure on the other knee.

You do not merely sit passively on the motorcycle. Instead all limbs should be brought into action as needed for complete vehicle control. Above all, remember that you are driving on the street and

## SIDECAR OPERATOR MANUAL

not on a race course. Consequently, the antics seen by both the driver and the monkey on a race track are neither necessary nor welcomed by the public at large or peace officers. This does not mean that it is not a good idea to properly understand the peculiar mechanics associated with sidecars and to practice them, if desired, on an offroad location such as a school parking lot on an off-school weekend. More on this later.

### Posture

A fairly erect posture will usually be the least tiring. A sustained amount of weight should not rest upon your hands while riding. The crouched position often seen for solo city driving just does not cut it for long distance touring.

### Turning

Directional control on a motorcycle-sidecar outfit can only be accomplished by turning the front wheel. In this respect it behaves like any two-track vehicles and totally unlike a solo machine. However, a different technique must be used when turning right at speed than is employed when turning to the left. This makes sidecar operation unique among all other vehicles. These skills are important to learn, and quickly.

Because the sidecar's mounting position affects handling, instead of describing right and left-hand turning operations, we will consider turning into or

## 3. CONTROL POSITION FOR SAFETY

away from the sidecar. Turning at slow speeds is very easy. Simply turn the handlebars in the direction desired. Balance and stability problems do not exist as they do for solo operation.

While most sidecars in the United States are mounted on the right, this is not universally so. A few are fitted on the left. Driving a left-handed outfit on the right side of the road is neither awkward nor hazardous. However, it does require more distance be allowed when overtaking to ensure that the road ahead is clear. Also, the operator will be riding adjacent to the roadside, where the road surface is frequently in poor repair. Your survival depends on having an outfit that can negotiate turns without difficulty.

### Turning Toward The Sidecar

(Right-Hand Mounted Sidecar)

A turn at speed toward the sidecar can cause the sidecar wheel to lift especially if the sidecar is empty or lightly loaded. This behavior occurs because the center of gravity of the outfit lies close to the motorcycle itself. Whenever any vehicle turns a force is generated opposite the direction of the turn. To compensate for this force on a solo motorcycle, you lean into the turn. In actual fact, to change the direction of a solo quickly one would deliberately turn the handlebars in the direction opposite to where you wanted to go. A force would then be generated in the opposite

## SIDECAR OPERATOR MANUAL

direction and push the solo over so that it is now leaning in the direction you want to go. This is called countersteering and it is popularly taught in modern motorcycle training programs. Of course, you could have simply leaned the bike over in the direction you want to go, but that takes a little longer before the turn takes effect.

A conventional motorcycle-sidecar outfit, MCSCO, cannot lean. So countersteering is out. The more experience one has on two wheels the less quickly he will adapt to a MCSCO. Conversely, the less experience he has as a soloist the easier he will adapt to MCSCO operations as he has less to forget.

There are two primary tipover lines, one between the front and rear wheels that is effective when turning into the chair, and the other between the front wheel and the SC wheel, effective when turning away from the SC. In theory, a third tipover line does exist between the rear wheel and the SC wheel - however that has not been relevant since the backwards facing rearcar lost popularity nearly a hundred years ago. With a heavy passenger and proceeding up a steep hill a heavily laden rearcar could tipover backwards!

The tendency for the sidecar to lift increases with speed, and as the radius of the curve decreases. Other effects include where the weight is placed, the track width, and the location of the CoG. As the tendency for the sidecar to lift begins a condition is created that is called "sidecar light". This means that if the weight on the SC wheel was taken while

## 3. CONTROL POSITION FOR SAFETY

the rig was turned into the sidecar that the weight would be less than it was when the rig was static or not moving.

Eventually a combination of velocity and turning radius can be reached when the centrifugal force generated will balance the weight acting on the sidecar wheel. The sidecar wheel will then float over the road surface, however, the rig will continue to steer correctly. From this point on, if the speed was to be increased still further, or the radius of the turn tightened more the sidecar would rise higher and higher. As this is happening the CoG is getting closer and closer to the tipover line. It is also moving from the stable turning condition into the unstable condition which will occur when the CoG is directly over the tipover line.

Any further increase in speed or tightening of the turn will cause the SC to flip over the bike.

Of course, once the rig is driven into the critical unstable mode it will then behave as an asymmetrical unbalanced solo where, if on an empty school parking lot it may be driven as a solo and steering reversion would apply. It might be useful to test this theory out, but NEVER on public roads. It is the same as driving your family auto on its two left wheels, if it has positraction, or a truck or a semi-trailer rig on its left side. Why not leave this to the stunt drivers?

**STABILITY  
& POINT of  
BALANCE**

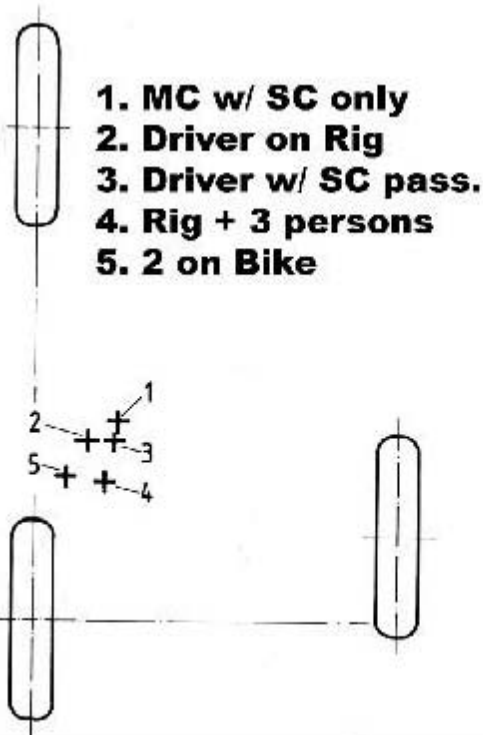
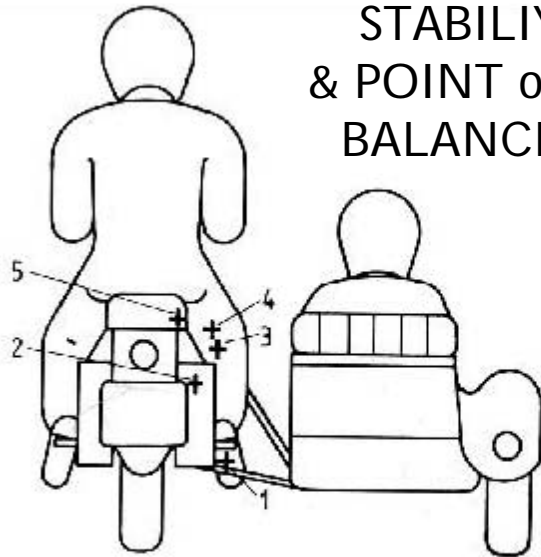

**3. CONTROL POSITION FOR SAFETY**

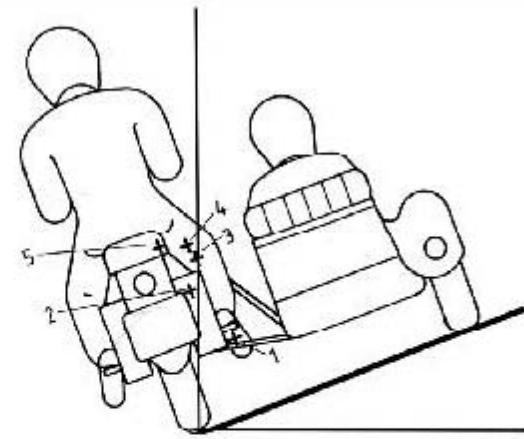
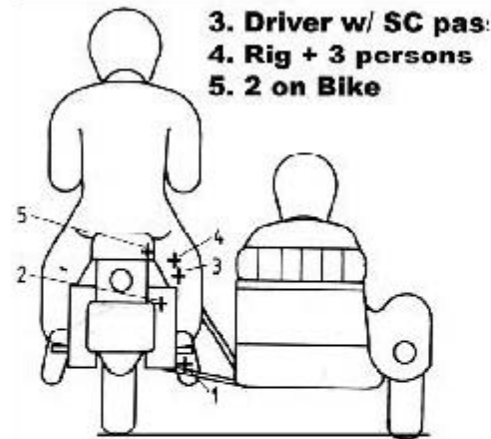

**3. PoB with Driver + SC Pass**

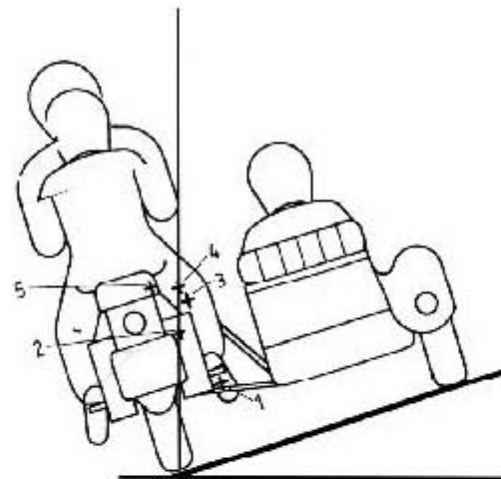

**2. PoB with Driver  
4. PoB w/ Rig + 3 persons**

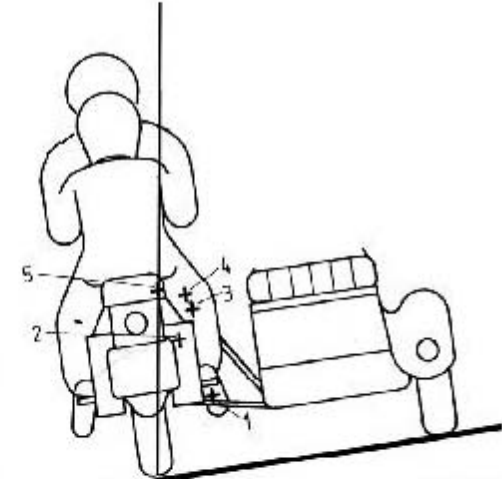

**5. PoB w/ 2 on Bike**

Note: The Point of Balance is where the CoG passes through the line between the front and rear wheels.

- \* Greatest angle with Driver and SC passenger, best stability.
- \* Driver only, or driver + SC pass. + pillion pass. not quite as stable
- \* Driver + pillion passenger - unstable by comparison!

## SIDECAR OPERATOR MANUAL

Correct turning toward the sidecar should be done as follows:

(a) Anticipate the degree of turn required, i.e., is it a gradual slow curve or is it a sharp right angle bend?

(b) Reduce your speed appropriately before entering the curve, by changing down through the gears or braking, or both as required. Upon entering the curve maintain speed, then accelerate gradually as you exit the turn.

Techniques such as applying the front or the sidecar wheel brake slightly, or moving one's weight toward the sidecar, should all be practiced. Each techniques will reduce the tendency of the sidecar to lift to some degree. However, there is no one size fits all. Some will find they are very comfortable to drive aggressively while other may feel out of their depth with these advanced techniques. Only you can determine just how much risk you are willing to live with.

If you are already entering a curve at too high a speed acceleration will only cause the sidecar to rise higher even higher. However, a racing sidecarist would cause the rear wheel traction to be broken by extreme acceleration and dropping down a gear or so. He would then broadside around the curve. This practice should be reserved for the racing circuit, not the highway.

Always slow down for curves into the sidecar. Racing techniques are for the race tracks.

## 3. CONTROL POSITION FOR SAFETY

If the sidecar lifts too easily for normal driving comfort, then the addition of ballast placed inside the unit or secured to the frame, as close to the sidecar wheel as possible, improves the handling.

### Turns Away From The Sidecar (Right-hand Mounted Sidecar)

Centrifugal forces act whenever direction is changed. On left turns the outfit pivots on a line between the front wheel of the motorcycle and the sidecar wheel.

Although the sidecar acts as a stabilizer or outrigger, the back wheel of the motorcycle can be picked up if the turn is too sharp or the speed is too high. This can be dangerous. The correct technique for turning away from the sidecar is :

Reduce normal road speed both prior to entering the curve and also during the curve itself. In this case, use the rear brake, not the front brake or the sidecar brake. Acceleration should begin when mostly through the curve.

Again, there are several advanced techniques which will permit you to drive into a lefthander at faster speeds, such as body lean to the left, and keeping the loads towards the rear of the sidecar. Unlike lifting the didecar, which is relatively slow and somewhat controllable, when you lose it on a lefthander it is quick and rarely controllable.



The photo and sketches on this page show the rollover line for a left-hander, between the front wheel and the sidecar wheel. Note that the combination of a middle-lightweight rig and a heavy sidecar passenger-contributes to the proble, Slow down before entering the curve, and accelerate when exiting the turn.

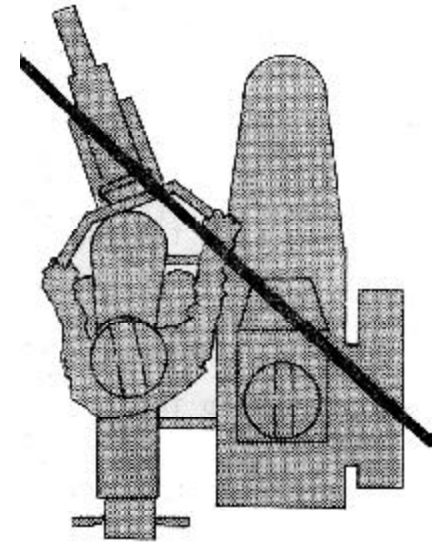

### Braking

Your sidecar outfit may have two or even three separate brakes. All are important. Strong application of the brakes on the outfit will cause different responses from those on a solo machine. Locking (skidding) the rear wheel, for example, will not cause the outfit to lose control, but is still not desirable. A skidding tire increases stopping distance. Maximum braking is achieved by increasing braking pressure until the threshold of skidding is reached.

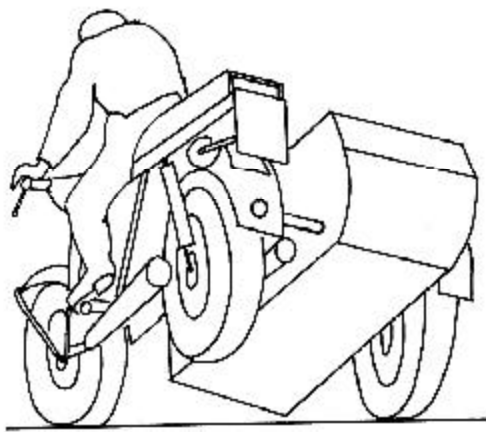

Because much of the sidecar's weight is on the rear wheel, the rear brake is more effective than it is on the solo machine. Rapid stops should be made by applying both front and rear brakes. The sidecar brake, if available, can also improve braking efficiency.

### Quick Stops

A sidecar outfit, unlike a solo motorcycle, has a very unequal weight distribution. Sudden and harsh application of the front brake can cause the outfit to slew around quickly. On the other hand, locking the rear wheel may do little more than accelerate wear on the rear tire. It will not result in loss of control, unless the front wheel is turned sharply to the left when the rig may slide by 180 to 360 degrees.

Both brakes should be coordinated to achieve optimal stopping distances. If a sidecar brake is installed, it can be used for emergency stops. But unless properly hooked up and applied with common sense, a sidecar brake may be a nuisance. Improved stopping power can be achieved by using softer disc pads or linings on the motorcycle brakes, by adding a second disc to the front wheel, or by converting a single leading shoe to a twin leading shoe. The latter usually involves changing the brake plate. The chain brake, if properly fitted and used, will also reduce stopping distance. A well braked outfit can stop in distances of 25 feet or less, from 30 mph, much less than any legally required stopping distances and as good as many solos or automobiles.

### Avoiding Obstacles

A quick stop may not be sufficient to keep from avoiding an object in your path. Using the side-

## 3. CONTROL POSITION FOR SAFETY

car characteristics you can execute a whip-change, either right then left, or vice versa, much faster than you can on two or four wheels. To change direction on two wheels you must first get the cycle to lean in the direction you want to go, whereas with an outfit you simply wrench the handlebars first one way then the other and your whip lane change is complete.

The whip-change is possible on a rig because even though you may have wrenched the steering wheel sharply to the right and the sidecar wheel begins to come up, it takes some time for the sidecar wheel to come up, but before then you have whip changed the other direction and now force the sidecar wheel down. Then you straighten out and travel is again normal.

If a whip lane change is insufficient to avoid an obstacle and you must make a panic stop to avoid a collision, lock both front and rear wheels. The outfit will come to a stop in the shortest distance possible but with minor loss of steering control. The outfit will stop in a straight line, but may swing around. You then present the side of the sidecar to the object rather than a head-on collision. This last is for extreme emergencies only, it should not be attempted until practiced first on a deserted gravel lot, then on an abandoned parking lot.

An emergency stop while turning into the sidecar may cause the outfit to move to the left across oncoming traffic.

## SIDECAR OPERATOR MANUAL

### Changing Gears

Selection of the appropriate gear is necessary to keep the engine within its correct rpm range. Use the lowest gear when starting off, and shift into higher gears as speed increases. Unless you have increased the gearing of your bike, numerically, you will find that you now need to feather the clutch more and employ higher engine speeds else you will stall out. Changing the gearing, numerically higher, will allow you to keep the engine speed lower when first starting off, and allow you to change into the upper gears sooner. You may also find that with a lower gear your top speed may increase. Never allow the engine to lug.

Downshifting is a very effective way to allow the engine to do some of the hard braking. To correctly downshift the throttle should be gripped slightly then closed as the gear change is made, with the clutch in, so that the higher engine speed is correct when the clutch is released.

When approaching a stop sign, always go down through each gear to slow down. This process insures being in the correct gear at all times, and in low gear when starting.

Pulling in the clutch while coasting or braking to a stop is not recommended; it is then necessary to shift through the gearbox until the correct gear is found. It is more difficult to shift the gears when stopped.

### 3. CONTROL POSITION FOR SAFETY

Always be in a gear that will allow smooth acceleration at any time except when cruising on an interstate or throughway, when the highest gear would normally be used.

### Shifting In A Turn

Downshifting during a turn away from the sidecar can use engine braking very effectively. On turns into the sidecar, however, the speed should be reduced and the correct gear engaged before the curve is entered. An advanced technique of a little throttle while gently braking the front wheel and throwing your weight towards the sidecar will give better control into righthanders.

### Starting On A Hill

Starting a motorcycle-sidecar outfit on a hill is no more difficult than starting it on flat ground. Use your rear brake to prevent rolling back while you start your engine, pull in the clutch, and engage low gear. With the brake still applied, gradually ease the clutch lever out until you feel the friction point. Now slowly open the throttle while slowly releasing the clutch. Let the brake off as the engine takes hold and begins to move the cycle forward.

## BEING PERCEIVED

Car drivers involved in collisions with motorcycles often claim not to have seen the motorcycle. Of course, they use this same excuse when they run into another automobile, a truck, or even a freight train. A pedestrian, a cyclist, or even a solo motorcyclist may be somewhat difficult for a motorist to see under some conditions. But a motorcycle with sidecar attached has an outline approaching that of a small car when viewed from ahead or even behind. Moreover, its unusual configuration will draw the motorist's attention to it.



## 3. CONTROL POSITION FOR SAFETY

### Headlight

Because of the motorcycle-sidecar's much larger frontal area, the headlight is less effective during daylight hours than the headlight of a small motorcycle. Studies conducted by the Road Research Transportation Laboratories in England have shown that the low beam headlight on a small motorcycle is not as good a conspicuity technique as dayglow garments or dayglow strips.

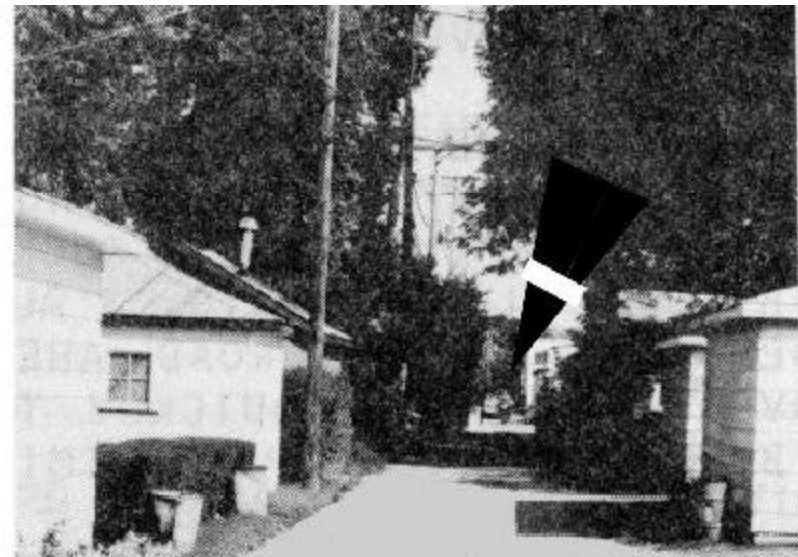

The outfit on the right has the light on (viewed from 150 yards).

## SIDECAR OPERATOR MANUAL

### Conspicuity (Visibleness)

Whereas the soloist has only a fairing, his own body, and a helmet that he can try to make more visible, the sidecarist can use the entire sidecar body to attract attention. Reflectorized or dayglow tape or bright colors on the sidecar body will greatly enhance its conspicuity. Conspicuity-enhancement techniques will not prevent all accidents. The motorist, however, is less likely to hit an object that is more clearly visible.

Many motorists claim they did not see the motorcycle until it was too late. Some studies indicate accidents are reduced by keeping the headlight on in daytime. Other studies are contradictory. Regardless, never rely on the headlight either to cause the motorist to see you, or to grant you your legal right of way.

### Position in Traffic

An alert motorist has virtually no space around him which cannot be observed by turning the head or using his mirrors. Though a car is usually equipped with two rear view mirrors besides the internal rear view mirror, the typical motorist drives with poor visual habits, and with only an occasional glance into his rear view mirror. Never assume he has seen you.

Even if he has, he may ignore your presence; a motorcycle-sidecar does not represent a threat to him as would a semi-trailer truck rig. Therefore,

## 3. CONTROL POSITION FOR SAFETY

stay out of obvious blind spots. Also, do not ride very close behind, or give him or her any reason to get annoyed with you. If the road ahead is clear and you wish to overtake, do so quickly then accelerate out of the way (but within the speed limit, of course).

With the sidecar attached, you will likely find that normal lane position is ideal for maximum line-of-sight contact with other vehicles at intersections. When coming up on a car from the rear, position yourself so that you are clearly seen in his rear view mirror.

### Maximize your own visibility.

When parking, always place the sidecar wheel against the curb. The width of the outfit should prevent other vehicles from crowding your space.

## 4. LOOK FOR TROUBLE SITUATIONS

Ali motorcyclists should be constantly on the lookout for potential trouble situations. With a sidecar attached, the motorist sees a vehicle approaching that begins to have a size comparable with his own. Reluctantly he may begin to recognize a sidecarist as a threat and allows him his right of way.

Good driving requires that you scan the road several seconds ahead to detect any suspicious movement, obstruction, or hazardous road situation, so you have plenty of time to avoid it or take corrective action.

Like a solo motorcyclist, the sidecar driver can use his height to advantage looking through the car ahead, to observe cars ahead of it that are stopping or turning.

If the car ahead then panic brakes you are prepared. Always watch the roadside for cars that appear to be parked but are waiting to get into the flow of traffic; for pedestrians, children, or animals who suddenly dart out into the stream of traffic without warning and without looking; and for a driver who has just parked.

His door may suddenly fly open without warning as he vacates his car, oblivious to the traffic situation.

## 4. TROUBLE SITUATIONS

### Head Checks

A motorcycle outfit has blind spots just as a car does, but for different reasons. Proper location of suitable mirrors can provide nearly complete coverage of what is going on alongside and to the rear. However, many cycles suffer from vibration at certain engine speeds, rendering the mirrors useless. It is a good idea to develop a practice of turning your head completely to the side to scan traffic movements behind you before changing lanes.

A sidecar outfit can make whip lane changes much more quickly than can a solo motorcycle or an automobile as mentioned previously. These rapid lane changes can surprise and frighten the motorist. Do nothing to ruffle his feathers. If you treat the motorist as a hibernating bear, your chances of survival will be enhanced. When changing from an outside to a central lane be sure there is not a motorist changing from the other side to the same lane, also. He will survive -- not you.

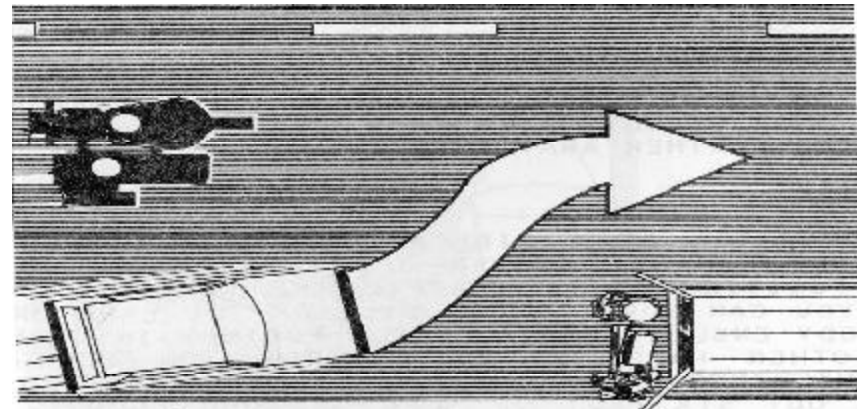

Watch Out

## Trouble Situations

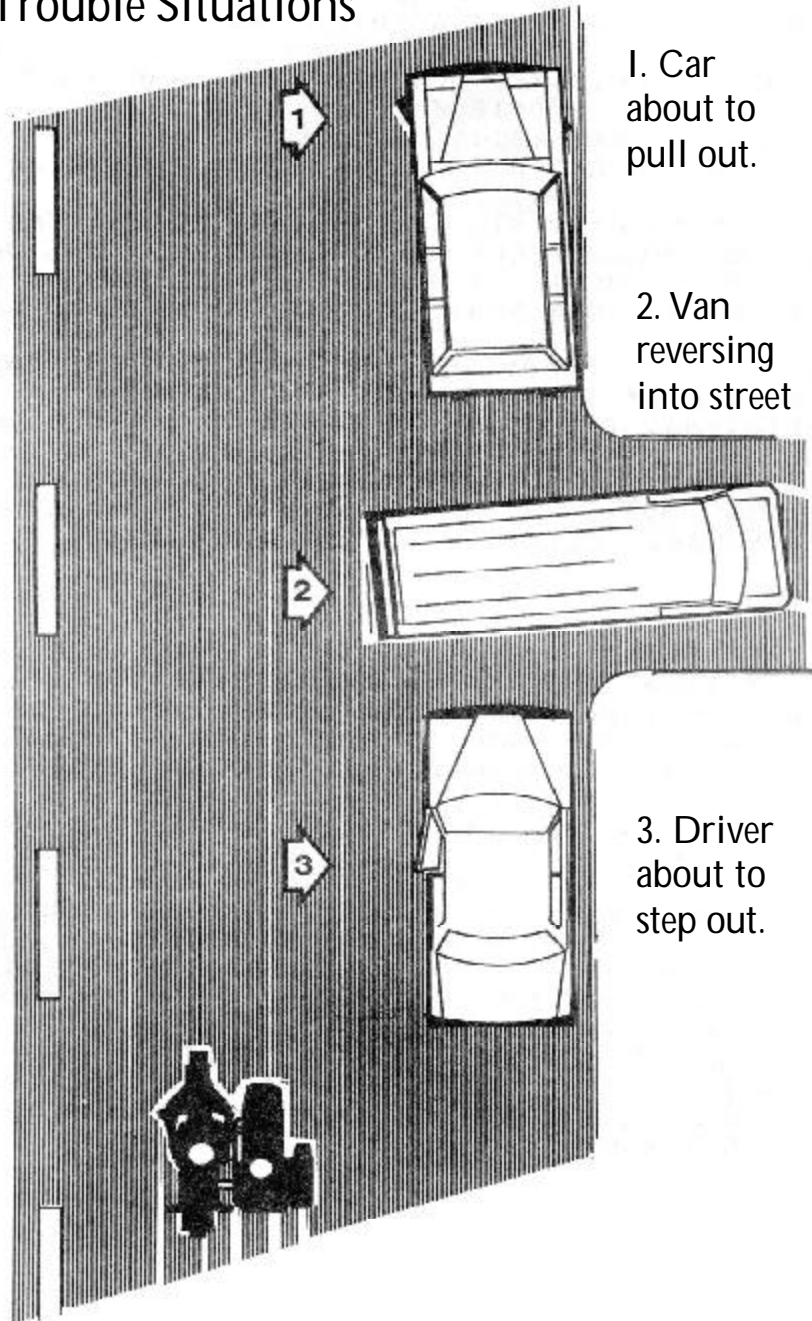

## 4. TROUBLE SITUATIONS

### Using Your Mirrors

Traffic situations change quickly. Always keep your eyes moving. Scan the road ahead, then glance to each side, and check each rear-view mirror. With practice, this will become routine. Try to gauge the behavior of those behind you and alongside you. Become totally aware of where you are and where they are. Try to predict what a motorist will do based upon his observed behavior pattern. In this manner you won't be caught off guard. A motorist will often accelerate to pass then cut in and rapidly brake to pull off the highway right in front of you.

Use your mirrors to watch behind you. You must become aware of tailgaters and "shake them". Do not allow a tailgater to stay behind you. If you cannot pull away without exceeding the speed limit, try slowing gradually until he either drops back or overtakes you. It may be necessary to pull off the road and allow him to pass, which is much safer than having him too close behind you in case you need to stop quickly.

When stopped at an intersection watch behind you. Unfortunately, there is little you can do to prevent the motorist from slamming into you from the rear if you cannot proceed because of a red light or cross traffic. Use both mirrors, signal, and turn your head every time you change lanes or make a turn. If convex mirrors are fitted, the distortion of distance results so that objects will appear farther away than they really are.

## Trouble Situations

### 1. Car pulls out from curb

Typical urban street scene. You are proceeding along an urban thoroughfare. You are intently watching the cars “parked” along the sidewalk. You suddenly see a telltale puff of smoke from the exhaust of a parked car immediately followed by the front left wheel suddenly angling out. You have several choices. You know, from past experience that the driver is not looking in his/her rear mirrors to see if there is any rearwards traffic, nor will you see a head poke out of the driver’s window, turn, and see if there is any traffic coming from behind.

No, and you can take this to the bank, that the driver’s eyes are frozen onto the left-rear bumper of the car ahead to ensure his/her right-front section of the bumper does not make contact as he/she tears out of the parking space.

What you do depends on what equipment you have. If you have just the OEM horn, don’t bother with it. That puny horn will not penetrate through the enclosed cocoon of glass and steel especially when the AC is on full blast to compensate for the heat soaked interior, and with the hi-fi turned up full blast to overcome the AC noise.

You can take a chance and “hope” the driver will see you and brake hard as he/she suddenly becomes aware of your presence. Also not good.

### 4. TROUBLE SITUATIONS

Or you can brake to a halt and allow the driver to get out ahead of you. Probably the best choice so far.

Or if you installed a set of airhorns with the built-in compressor, a small blast may get the driver’s attention. On the other hand, the driver may react adversely and unexpectedly.

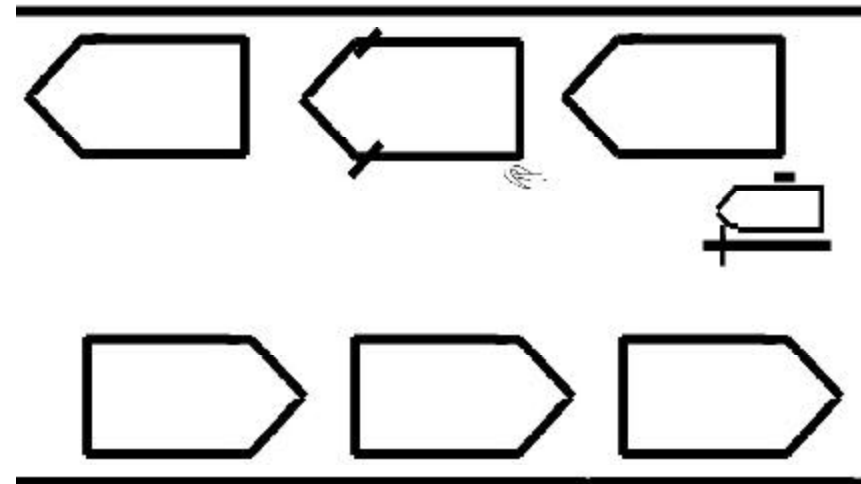

Driver about to pull out into your space

### 2. Driver Steps Out

Same situation - urban thoroughfare. Row of parked cars. This time, driver spots a puff of smoke stop from a parked car. Also sees slight movement of the driver’s door. Based on past experience, driver knows that auto driver is about to slam his driver’s door open and exit into the street. Driver did not see driver’s window roll

## SIDECAR OPERATOR MANUAL

down and a head protrude to see if all was clear from behind. Also, that driver did not check rear mirrors so was entirely ignorant of approaching sidecarist.

What to do? As auto engine off there is a possibility that auto driver may hear OEM MC horn. Sidecarist can brake to a stop and allow the car driver to alight, perhaps the safe and manly thing to do.

Or, a blast of the air horn might get the required response, but do not count on it.

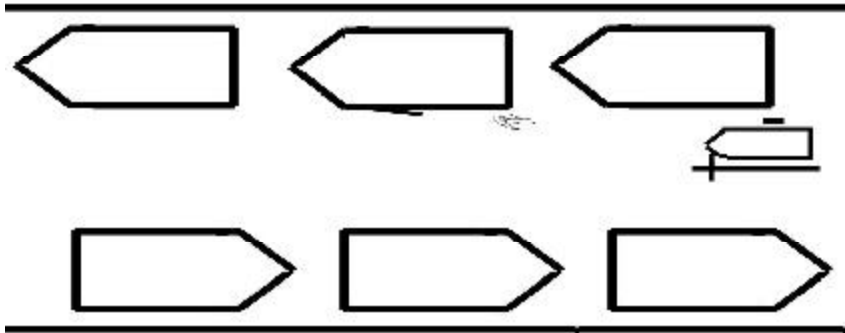

### 3. Driver Reverses into Roadway

Same situation - urban travel - now in the residential area. As you proceed down the residential street on a weekday mid-afternoon you see a woman reversing down her drive and soon to reverse onto the road.

Yes, she should be looking to the right and to the left to ensure the road is clear before reversing onto the roadway. But in fact just where is she

## 4. TROUBLE SITUATIONS

looking? Cannot be too sure but it is in one or the other of two places. Either dead ahead to ensure that the automatically closing door is in fact closing properly, else dead behind to ensure she does not run over Johnnie's bike he left lying on the driveway. She is certainly not looking either up or down the road to ensure she can back onto the road in safety. What do you do?

You can try your puny OEM horn but for reasons stated it probably will not get her attention. You can stop and allow her to complete her unsafe operation. This is definitely the safest if you can stop without making the situation worse.

Or you can hit her with your air horn. This might work, but then again, it might not bring the desired response from her.

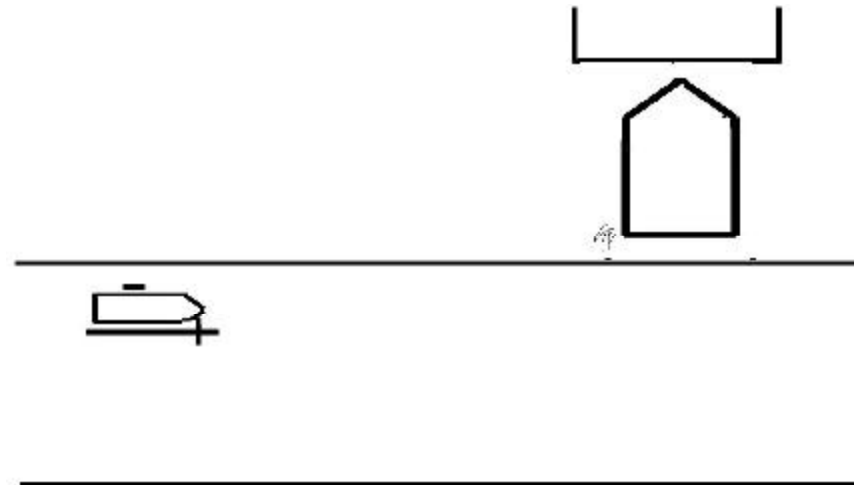

## 5. Control Positioning

### Positioning

As the operator of a sidecar outfit you are not much better off than the driver of an automobile as far as optimum positioning in traffic is concerned. To some extent, you can move to one side of the lane or another and by body english see a little further into the curve.

On the other hand, at an intersection you can peer around buildings, parked cars, or bushes without having to stick out six feet or more of your hood. Also, if planning to execute a U-turn, you can angle the outfit into a position from which you can easily observe oncoming traffic.

## KEEPING SPACE CUSHION

The safest protection you can provide is a space cushion between yourself and other road users. If someone makes a mistake, there is time to react, and you can seek a place of refuge.

### Following Distance

The two-second rule is an easy way to judge a safe following distance. It allows a sufficient distance between you and the car ahead to react if necessary.

Pick a landmark, such as a road sign or an overpass, in front of the vehicle ahead of you. Begin counting when that vehicle passes the stationary

## 5. CONTROL POSITIONING

object. "One thousand and one, one thousand and two". You should arrive at that landmark at the same time you say "two", or later. Many suggest that a gap of 3 to 5 seconds is even safer, if it can be maintained. Keep this distance from the car ahead even when traffic slows or stops. If a motorist behind you does not stop, at least you may have a chance to move up and get out of his way.

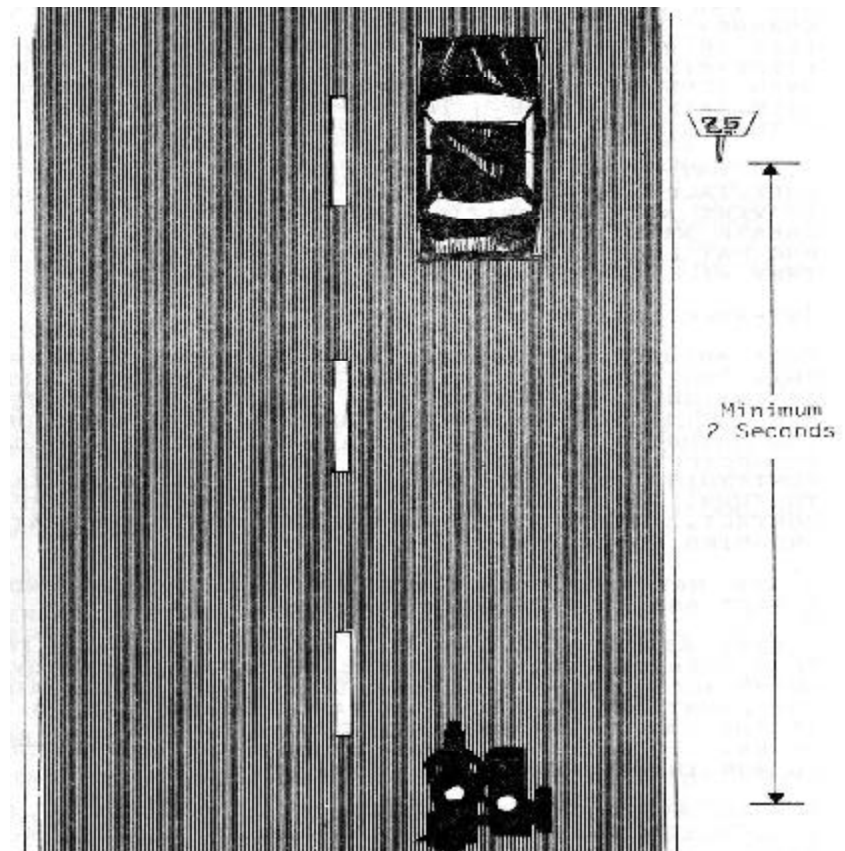

The Two Second Rule

## SIDECAR OPERATOR MANUAL

### Distance to the Side

Avoid riding next to any other vehicle. This will insure you can move laterally if a problem arises. The driver of a sidecar outfit like the motorist cannot alter his lane position appreciably, unlike the soloist who can alter his lane position as traffic conditions change. Still, as the average outfit is less than five feet in width in lanes that may be ten feet or more, the sidecarist can move over to some extent. When being overtaken, for example, crowd the lane opposite to the overtaking vehicle. If traffic is of uniform density on either side, stay in the center of your lane.

Give way to any motor vehicle that is larger than you, especially large trucks and buses. In addition to their drivers not recognizing you as a threat, they can also create wind gusts that buffet you. Unlike the soloist who may lose control, in strong gusts, to the sidecarist they will simply be a mild discomfort to you.

### Intersections

Most motorcycle-car collisions happen at intersections. This may be partly due to the drivers not paying attention to their driving (they also hit pedestrians and cyclists) and partly due to their lack of fear of the motorcyclist. A typical accident is as follows: A motorcyclist, with or without his lights on, is continuing straight ahead. The approaching car signals to turn, comes to a full

## 5. CONTROL POSITIONING

stop, establishes apparent eye contact, then proceeds directly into the path of the oncoming motorcyclist.

A car may also pull into the main street from a side street and collide with the motorcyclist. Always assume the car will enter your path if it can.

Your greater width and increased conspicuity over a solo motorcycle may offer some degree of protection but do not count on it. Move as far from the car as possible.

If the car is on your right move to the left, and vice versa. If possible, change lanes and use other vehicles to run interference.

Always approach intersections slowly, in a gear that will allow maximum acceleration if necessary. If the driver does want the spot you are in, brake, swerve, or accelerate to get out of his way.

### Parked Cars

When passing parked cars, the sidecarist has little advantage over the motorist. Drivers of parked cars often fail to look behind them and open their doors with gay abandon. When pulling out, they are often more concerned with whether their right front bumper will hit the left rear bumper of the parked car ahead than with what damage or consternation their pulling into traffic will have. They may suddenly execute a U-turn in front of the motorcyclist, leaving him with no place to go.

## SIDECAR OPERATOR MANUAL

Always check parked cars for any signs of movement such as the sudden turning of the front wheel or the tell-tale puff of smoke from the exhaust. Approach cautiously with the fingers on your left-hand poised on or near the horn button or headlight flasher or both, and the fingers of your right hand poised over the brake front lever.

### Sharing Lanes

Cars and motorcycle-sidecar outfits each need a full lane to operate safely. Do not share a lane. Your width does not allow you to squeeze between adjacent traffic lanes. Nor should two outfits ride abreast in a single lane, although this may sometimes be permissible for solo motorcyclists. Always discourage a potential lane-sharer by staying in the center of your lane. Be prepared to drop back and yield your space if another road-user insists on taking it.

### Merging Cars

Cars entering a highway from an entrance ramp often are not concerned with disrupting the traffic flow on the highway, especially if they see only a small vehicle in their path. Change lanes or yield your position rather than risk an altercation.

## 5. CONTROL POSITIONING

### Cars Alongside

Unless traffic is bumper-to-bumper, do not ride alongside other vehicles. Motorists often change lanes with a total disregard for other vehicles, especially those smaller than themselves. Always try to keep a clear space on either side for emergencies, should anything happen in your lane.

### Distance Behind

Be constantly aware of tailgaters. Change lanes, if possible, and let them go on their way, or try to open up additional distance. If necessary, pull over and stop. Better the tailgater on another motorist's bumper than on your unprotected rear wheel.

## 6. HANDLING UNUSUAL SURFACES

A sidecar outfit is one of the most stable vehicles, on or off the road. When irregular surfaces such as ice make normal travel difficult, the sidecarist will find little difficulty. Snow, slush, sand, oil slicks, wet manhole covers, painted lines, uneven road surfaces, road bumps, or even patches of black ice are dangerous to the solo motorcyclist but present few problems to the sidecarist. Part of the sidecar's unique ability to handle all road surfaces is that one wheel is used for steering, one for traction, and one for stability. Each performs its allotted task.

Regardless, the sidecarist always should show respect for such surfaces, approaching and traveling on them with caution. There is never any need to use your feet as outriggers as one would on a solo machine. For glare ice or mud, chains are available for added traction. These chains are similar to those used on solo machines for hill-climbing.

### Uneven Surfaces

Watch for uneven surfaces such as bumps and broken pavement, chuckholes, and railroad tracks, and approach with caution. Rarely will you encounter a situation bad enough to lose control, but traveling over such surfaces at speed will do neither your machine nor your kidneys any good. Therefore, if they cannot be avoided

## 6. HANDLING UNUSUAL SURFACES

slow down and try to cross any minor obstacles head-on. Take care not to straddle rocks protruding from the road bed with a low slung outfit. You can get high-centered and damage an unprotected fiberglass sidecar bottom. Shock of impact over rough road surfaces can be lessened by rising slightly on the footpegs and allowing your knees and elbows to absorb the shock. However, your sidecar passenger will experience a rough passage.

Most railroad tracks do not present any problem and may be crossed at any angle without fear. It is best, however, to cross at an angle over rails running parallel to your path, to avoid catching a tire alongside the rail.

### Riding Over Objects

Sidecars can be driven over extremely rough ground with any or all wheels in the air with no loss of control. Just take care not to high center a low-slung chair on a protruding object.

Sometimes you have little choice but to ride over an object in your path. If an object must be ridden over, keep a firm grip on the handlebars. Keep the course straight, and rise slightly on the footpegs to allow your knees and elbows to absorb the shock. Check tires, wheel rims, and spokes for damage after hitting a solid object.

## SIDECAR OPERATOR MANUAL

### Grooves and Gratings

When driving an outfit over rain grooves or metal bridge grating, little traction change will be noted. No loss of control or even a tendency to wander is experienced as might be the case with a solo motorcycle.

### Sloping Surfaces

Driving an outfit on a severely sloping surface will tend to make it want to edge off the road. A solo motorcyclist would compensate for this by leaning up-slope; this has no effect on directional control with a sidecar. Instead, pressure must be exerted on the handlebars, pulling one and pushing the other, to maintain travel straight ahead. If a sidecarist often drives on high-crowned roads, he can compensate by adjusting motorcycle lean-out slightly, or by increasing toe-in, or both. When driving on flat roads the outfit would now have a tendency to veer to the right, unless pressure is placed on the bars to straighten the rig.

The only effect of turning an outfit to the left on a severely banked right-hand surface is that a little more force must be applied to the handlebars to turn. On the other hand, turns to the right will be considerably easier. Normal road speeds are permissible for sidecar outfits on sloping surfaces.

## 6. HANDLING UNUSUAL SURFACES

### Corrugated surfaces and Gravel Roads

Off road driving is generally more forgiving than concrete and macadam. Your rig is stable. You will find you can drive faster than your skill so slow down and drive very carefully. With only 55 percent of the 900,000 km of roads paved in the US there is an awful lot of unpaved roads to investigate.

Corrugations are a fact of life with any road surface - whether sand, gravel, concrete, or macadam. Occurs even with rail lines. The same principle causes the cyclic wear pattern in ball and roller bearings. So let's deal with them.

A corrugation forms in dry materials only, not in wet or muddy surfaces. At very slow speeds you will feel each bump as you go over it. At higher speeds the vibrations become less, until you reach a resonance speed where it feels like your vehicle will come to pieces. Above or below the resonance speed you will find a speed where the effect is minimal. Always try to find a speed below the resonance speed where you feel safe.

Slow down for curves to left or right. There is less chance to lift the chair as you will slide. Practice turning and sliding on loose gravel until you find how your rig behaves. Can you do figure 8's, slowly at first, always under full control? Above all, do not turn the front wheel sharply. It will not turn but will just plow ahead.

## 7. NIGHT RIDING

The primary purposes of your headlight(s) and other lighting are to be able to see clearly, and to be clearly seen. Those who use only a single headlight or taillight at nighttime are not really looking after their own safety. Unless you clearly define your width by at least small running lights on the outside of the sidecar, white or yellow to the front and red or yellow to the rear, the oncoming driver will believe you are just a solo motorcycle and may force you off the road.

Your width is not clearly discernable to him, as you have partially blinded him with your headlight so that he is looking at the edge of the road, not at you. With the outside running light, he will at least believe you are a one-eyed car or truck and give you the room you require.

The situation is not as critical for an overtaking motorist who should be able to clearly see your width, with or without the rear running light on the sidecar.

Still, it is more prudent to install running lights front and rear. Reflector strips can be used to great advantage over the entire body of the sidecar for maximum nighttime conspicuity.

Your need all the lights you can use at nighttime, especially when traveling on narrow winding roads. Always use your high beam when not following or meeting a car. Switch to quartz-halogen beams if not installed as original equipment, if

## 7. NIGHT RIDING

your electrical system can supply the slight additional drain. Not only will you get a cleaner, whiter light that penetrates farther than the old tungsten filament bulbs or normal sealed beam units, but quartz-halogen lights also provide a crisp, clean cutoff on low beam, so that the oncoming or followed motorist is not as dazzled as he is with other headlights (if your lamp is properly adjusted).

Note: The American sealed beam quartz-halogen lamps do not have the crisp cutoff on low beam that the European replacable quartz-halogen lamps have. Even the newer F5 US Q-H replacable bulbs are not as crisp as the H-4 Q-H bulbs.

If your system has sufficient electrical power, you should consider an additional headlight on the sidecar which may contain a driving beam for use when not passing or meeting another vehicle. The light may also have a dual filament and be used as a normal headlight.

Always check your local State code to make sure your additional lighting is legal. If vehicle lighting is inadequate, slow down. Never overdrive your headlights.

Sometimes you may let another car lead if you have confidence in that driver (or you both may get lost). Spaces between vehicles should be increased at nighttime, because distances are not as easy to judge. This includes following distances. More space should be left when overtaking.

### 8. EMERGENCIES

On occasion you will find yourself in a tight situation no matter how careful you are. Studies indicate some motorists and motorcyclists neither braked nor took evasive action prior to impact. Had they responded appropriately, the impact might not have occurred. Certainly the consequences would have been lessened.

#### Avoiding Obstacles

A quick stop may not be sufficient to avoid an object in your path. Using the sidecar characteristics you can execute a whip-change, either right then left, or vice versa, much faster than you can on two or four wheels.

To change direction on two wheels you must first get the cycle to lean in the direction you want to go, whereas with an outfit you simply wrench the handlebars first one way then the other, and your whip lane change is complete.

If a whip lane change is insufficient to avoid an obstacle, and you must make a panic stop to avoid a collision, lock both front and rear wheels. The outfit will come to a stop in the shortest distance possible but with minor loss of steering control. This last is for extreme emergencies only, it should not be attempted until practiced first on a deserted gravel lot then on an abandoned parking lot. An emergency stop while turning into the sidecar may cause the outfit to move left across oncoming traffic.

### 8. EMERGENCIES

#### Minor Emergencies

The following should not cause the sidecarist to lose control but are possible emergencies :

##### (a) Flying Objects

Objects such as cigarettes, cans, bottles, or other debris are constantly thrown from automobiles. Sand, gravel, and all manner of sundry items fall from the back of trucks. Loose or fresh road surface materials may be kicked up by the tires of large trucks. Insects, bugs, and birds have collided with motorcycles on occasion. Without face protection of some type, you could be struck in the mouth, eyes, or nose. If wearing a face shield, it could become cracked or smeared. Above all, do not lose control. Keep your eyes on the road and your hands on the handlebars. Pull off the road as quickly as it is safe to do so, and repair the damage.

##### (b) Animals

Domestic and wild animals should be avoided. Motorcyclists have been killed in collisions with all types of animals, including dogs, horses, deer, and cows. Slow down as soon as an animal is seen, while gearing down so that you may rapidly accelerate if the situation warrants. If traffic allows, swerve out of its path. If the animal is small and you can neither swerve nor stop, try to hit it with the nose of your sidecar or sidecar wheel. You will do far less damage, and you will not lose control.

## MECHANICAL FAILURES

### Blowouts

A blowout on any of the three wheels of a sidecar outfit is not really critical unless you happen to be executing a particularly serious maneuver at that precise instant. The motorcycle tire is little more than a narrow tube of air. Rarely will a tire come off the rim if the tire is held on with rim locks. Rim locks should be added to the rims of older machines for improved safety.

Steering will feel heavy if the front tire blows. It will also feel quite bumpy. Glance down, visually checking the tire condition. A flat tire will be distended where it meets the road surface. If the rear tire blows, the rear end will feel quite bumpy. It will also feel a little "swishy".

A flat tire on the sidecar can sometimes be difficult to perceive because it normally has so little load. It may be noticed most when turning to the left. You may find the outfit begins to pull a little more, or that the whole machine leans toward the sidecar just a little. The effect will be magnified when the sidecar is loaded.

Should a blowout occur, simply hold the bars firmly, slow down, and steer off the road as soon as it is safe to do so. Normal braking can be applied to any wheel other than the one with the blown tire. Unless the rear tire has blown, the braking effect of the engine can also be used to assist in slowing. With three tires rather than

### 9. Mechanical Failures

two, and one tire serving to maintain stability and balance, the effects of any blowout are minimal.

#### Stuck Throttle

Sometimes the throttle may refuse to close due to a cable or linkage problem. If this occurs in traffic or while negotiating a decreasing radius curve, you could be in trouble. The first thing to do is to use the ignition cutoff switch to turn off the engine. If you pull in the clutch instead, the engine will turn too fast. Depending upon engine revs at the time the clutch was pulled in, the engine could reach very high speed, well into the red zone. As soon as you discover the throttle is stuck, turn off the engine, ease off the road safely, and determine the cause.

#### Wobble

The only wobble sidecarists are likely to encounter is slow-speed front-wheel wobble. They are hardly likely to experience high-speed weave. If wobble exists it will usually be felt at speeds between 5 to 30 mph.

Normally, it is easily controllable by simply gripping the bars firmly. Generally, it presents only a minor aggravation and will not lead to loss of control. It can usually be eliminated or reduced by installing a friction or a hydraulic steering damper. Some outfits require no damping, others a little, a few a lot. Too much dampening if not needed will deaden steering response.

### Engine Seizure

Engine seizure is the result of tremendous overheating which may be caused by lack of lubrication or, sometimes, by improper break-in procedures. Symptoms of an impending seizure are loss of power and a change in the sound of the engine. If this is noticed, close the throttle and pull in the clutch. Pull off the road as soon as it is safe to do so. If the machine is driven until the engine seizes completely, a massive overhaul of the engine could be necessary. A minor seizure may be of little consequence if the engine has been allowed to cool down.

If the rear wheel locks up it should not result in a loss of control of the motorcycle outfit. Simply pull in the clutch to free the wheel, then brake to a stop when prudent to do so.

If the problem was lack of oil, fill with oil and determine the source of any oil leakage.

### Getting Off The Pavement

Some tips if you have to leave the roadway - First, check that the shoulder is wide enough to accommodate your motorcycle outfit including space to comfortably walk around and inspect or repair without it being a hazard to other road users. The condition of the off-road surface is of little importance unless it is of large, harsh, broken rocks. Be sure to use clear signals of your intent to pull over, and look behind to be sure it is safe to do so.

## 9. Mechanical Failures

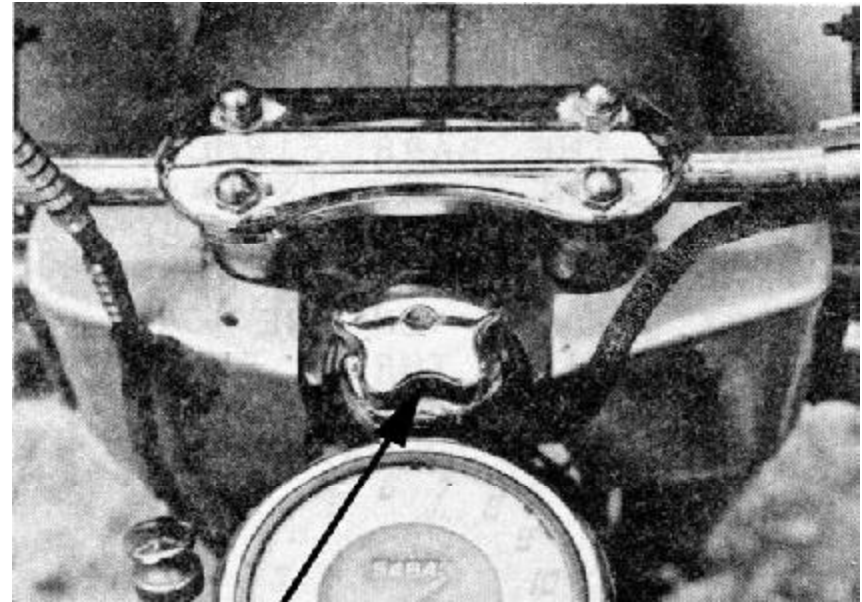

Adjustable Friction Steering Damper

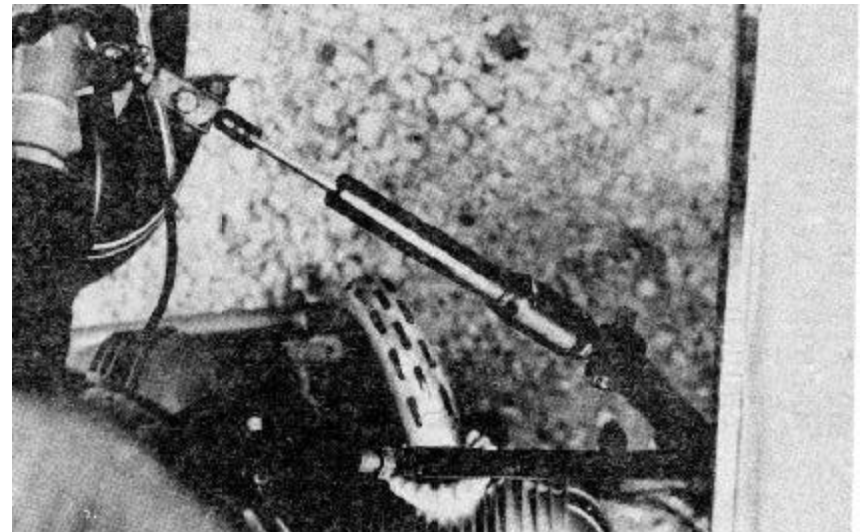

Non-adjustable Hydraulic Steering Damper

## CARRYING PASSENGERS/CARGO AND BALLAST

A motorcycle and sidecar are designed for carrying passengers and cargo. The extra weight does not present any serious change in handling characteristics if a little thought is given to where the passengers or cargo are carried. With a sidecar attached the best place for the passenger is in the sidecar. **Do not put a single passenger on the back of the motorcycle saddle.**

A second passenger can be placed on the rear of the motorcycle saddle, if the seat is designed for two persons, and if footpegs have been provided. When two adult passengers are carried, be careful not to exceed the load rating of the rear tire.

Passengers in the sidecar are protected in an enclosed carriage which usually has a windshield. Protective clothing is generally recommended. However, the sidecar outfit is a family unit, and safe carriage of infants and small children is commonplace.

If motorcycle helmets are not available for very small children, bicycle helmets may be an alternate solution.

Always use the best helmet available even if not DOT approved in small sizes.

When carrying a child and an adult passenger, it is very bad practice to put the child in the sidecar and the passenger on the rear of the motorcycle saddle.

### 10. Carrying Passengers, Cargo, Ballast

This can upset the balance and handling. The heavy load should always be in the sidecar. If for some reason it is necessary to load the outfit thusly, additional ballast should be added to the sidecar.

Some types of ballast are:

1. Installation of a 12 volt car battery behind the sidecar seat. This can be an effective way to increase electrical storage capacity by linking the battery to your machine's electrical system. It also improves starting power in cold weather.
2. A 3 to 5 gallon fuel tank can be added behind the sidecar seat, but this could present a substantial fire hazard in a collision. Another method used is to install a long, small diameter, cylindrical fuel tank above or below the sidecar frame. This adds to the effective driving range of the outfit but you need to be sure you do not get high centered.
3. A piece of flat steel plate may be mounted on top of or within the sidecar frame and below the body.
4. Steel weight or lead weight can be affixed to the sidecar frame as low and as close to the sidecar wheel as possible.

Very few special precautions are needed when cargo or passengers are carried. You may find performance has been cut slightly and that stopping distances are longer so allow a little extra distance for this. The addition of the sidecar passenger will greatly improve stability.

## SIDECAR OPERATOR MANUAL

You will find that the sidecar is now more difficult to get airborne when turning toward the sidecar, though it can still be done (don't try it with the passenger).

Those curves can now be made at faster speeds. With the sidecar passenger, more turning force will be needed when turning away from the sidecar. And on high-crowned roads you may find yourself tugging at the handlebars a little more now.

As the passengers are firmly in the sidecar, it is not necessary to give them any special instructions. They can get into the sidecar at any time, as long as the outfit is stationary.

If the sidecar is designed for two adult passengers in tandem, a lone passenger should sit in the rear seat. If the sidecar is loaded, and an added passenger is carried on the rear of the operator's saddle, that passenger should sit upright at all times. It is not necessary for the passenger to lean into curves with the operator as when riding as passenger on a solo machine.

### Cargo

A sidecar outfit is ideally suited for carrying loads, as long as the weight does not exceed tire or sidecar loading capacity.

Loads should be distributed toward the rear of the sidecar, to reduce tipping of the nose on sud-

## 10. Carrying Passengers, Cargo, Ballast

den turns away from the sidecar. Loads should be firmly tied in place, and within the sidecar if possible.

If the load is placed on top of the sidecar the ties should be checked frequently.

## SIDECAR OPERATOR MANUAL

### TRAILERS

The sidecar outfit can pull medium sized trailers quite safely. Trailers can contain additional cargo or portable tents. Some trailers are towed from the rear of the motorcycle, just as they are for a solo machine. This increases the width of the motorcycle-sidecar combination quite drastically. Consider that a trailer will be from 42 to 56 inches wide and the motorcycle with sidecar will be from 42 to 73 inches. Using the H-D as an example of the larger bike, the overall width of MC, SC, and trailer is about 106 inches for the in-line hitch, see next page.

Others prefer to tow from the inner sidecar frame. This allows the trailer to track evenly behind the sidecar outfit and reduces the overall width of the combination to about 84 inches. In either case, no difficulty is experienced in towing.

The ideal position is the one where YOU feel comfortable. From my experience, I have found the offset tow puts additional weight on the sidecar and makes right handers more stable. I had no problems with braking or accelerating. Be sure you allow for longer braking distances and slow down for corners both to right and left.

When starting, feather the clutch more and feed the throttle a bit more, but within reason,. There is no need to redline the engine. Feed the clutch slowly and progressively.

### 11. Trailers

Follow all State codes regarding safety chains and lighting required for trailers. Whereas the sidecar can be used for either cargo or passengers, the trailer must only be used for cargo. Gone are the days when trailers were used for passengers. Today, the only passenger trailers seen are for small children behind bicycles in the parks, and for near empty Metro Buses in the 'burbs.

The addition of a trailer will reduce performance and increase braking distances, which must be allowed for in your driving habits. This is especially true when going down steep hills. Use your lower gears to aid braking, and do so before you feel you really need to use those brakes.

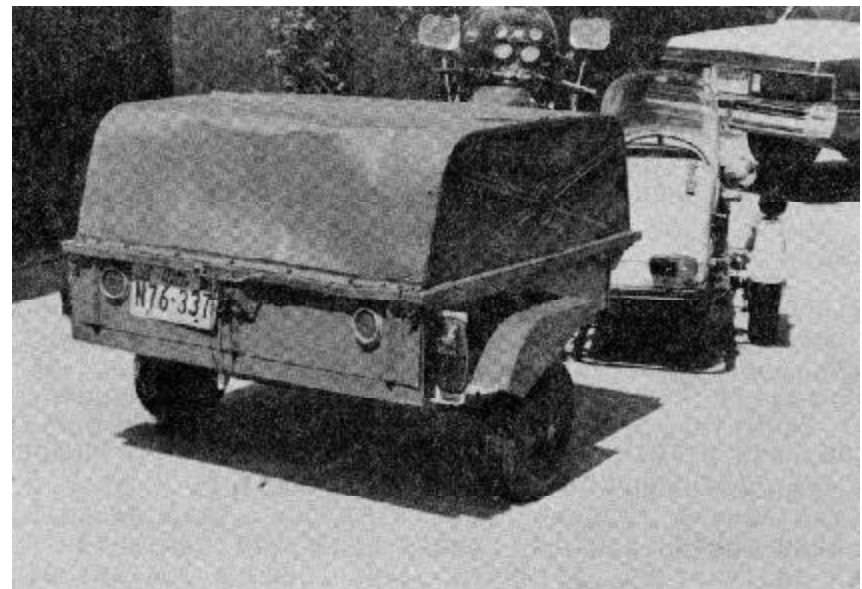

Small auto/large MC trailer- towball offset to right - track of trailer follows track of MC/SC outfit

## SIDECAR OPERATOR MANUAL

Another factor is that even a small trailer allows you to pack additional items more easily and securely for extended trips than is possible with just your sidecar. Unless your sidecar is a Watsonian Oxford DL or a Gemini 3 seater you have very limited cargo capacity, especially if you also carry a passenger. A small trailer will follow you easily without an offset hitch but the narrow trailer track is not as stable as a wider track.

The support frame for the hitch must be very well designed whether it is at the rear of the bike, or is offset and on the sidecar frame. Whether a ball or a universal swivel is used it must provide for a positive non-slip and non-loosening connection to the frame. It must allow for at least 90 degrees of horizontal rotation and at least 30 degrees of vertical rotation.

## 11. Trailers

The “universal” hitch will fit most smaller Jap bikes but the BMWs, H-Ds, and larger Jap touring bikes will usually need specialized or custom hitches. The offset hitch will most certainly need to be custom fitted but can usually be fabricated from stock components. If fitting an offset hitch, be sure that the sidecar frame is well triangulated so that the pull is transmitted to the bike and not to just the sidecar frame. This can usually be done by installing a fifth mount from in front of the ball to the upper right shock mount or under the seat. All mounting points for either the sidecar or the trailer should be on the main frame and not on any auxiliary frame component such as a brake stay, or a pillion footrest support. If in doubt, always get a second opinion from a recognized expert in this field such as an installer or builder of sidecars or motorcycle trailers.

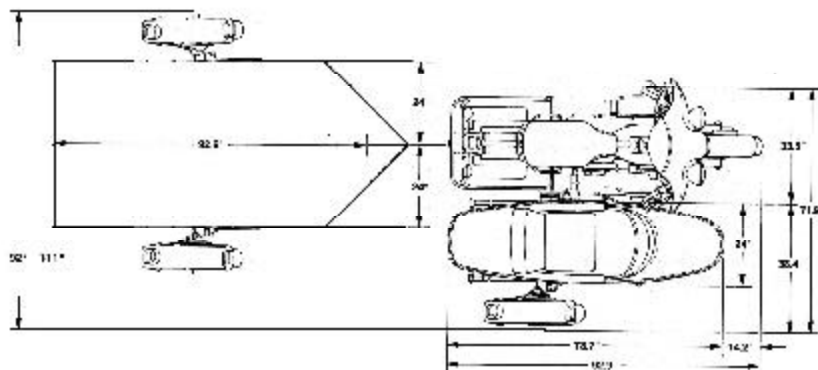

H-D FLHT/TLE w/ in-line Trailer: 92-111 ins

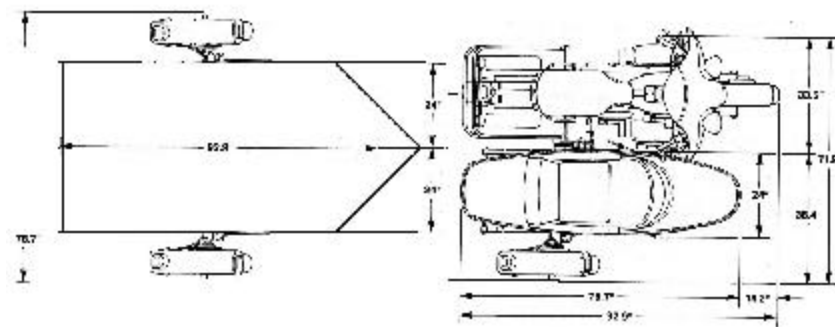

H-D FLHT/TLE w/ offset Trailer: 79-83 ins

## SIDECAR OPERATOR MANUAL

A trailer should always be loaded so that is balanced (from left to right) and so that there is a positive load of between 35 to 75 pounds on the hitch. There should never be an upward force on the hitch, not should it be extremely heavy. An empty trailer is not a good idea. It can bounce alarmingly, especially if the tires are over pressured and there is no suspension or very stiff suspension. A medium suspension with hydraulic damping is more or less ideal.

Brakes are an excellent investment on medium to heavy trailers but not really necessary for lighter trailers if your rig is already equipped with large dual disks up front, a large rear brake, and a good SC brake tied into your rear brake system.

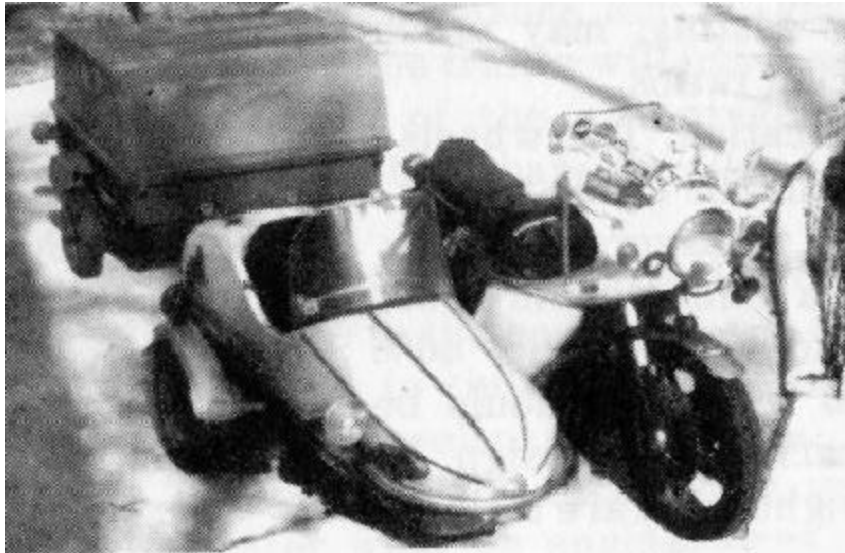

Large trailer tracks ideally within MC SC track

## 11. Trailers

You are not out of the woods with wobbles and vibration after sorting it out with your sidecar. The trailer can provide sway as well as vibration and wobbles. Check out the obvious, out of round or out of balance tires, rims, or wheels, and loose or worn bearings. If not, then see if shocks on the trailer will help. If there is a speed where the trailer begins to sway, stay below that speed. Do not attempt fate by trying to drive upwards through the swaying mode. I had a trailer that began to sway because of overloading and worn and dry wheel trailer bearings. The trailer almost capsized but did not go over as the trailer wheel collapsed, the tire blew out, and the trailer axle bent. A costly learning experience.

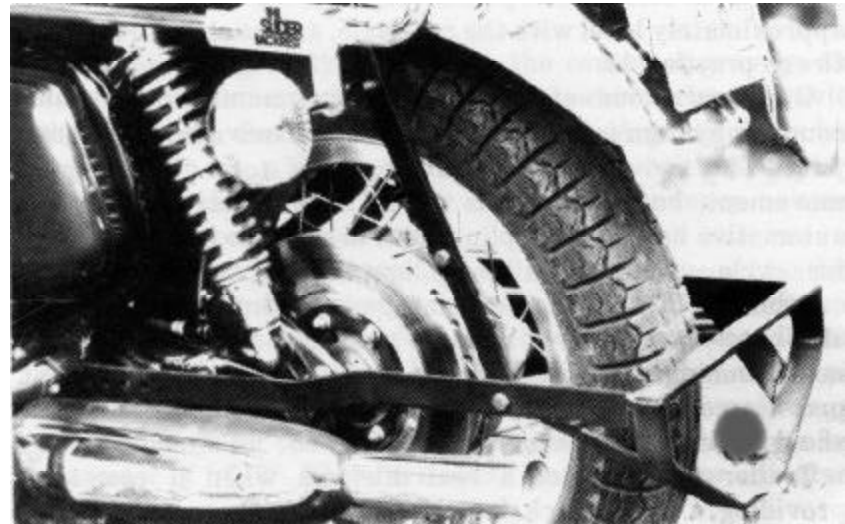

Cycle Mate Rear Hitch

Now for more driving tips - start out slower, accelerate less, and plan to slow down more. While it might be smart to lock the rear wheel of the sidecar rig for sharp broadsiding ledthanders, to do this when pulling a sidecar can be disastrous, especially if the trailer jackknifes on you. If your rear wheel locks, unlock it, now! Practice slowing and stopping, and using your gears to slow down. Use your trailer brakes before you need them to see how they feel. They should not be a problem if travelling ahead but may give surprises if on a sharp turn.

When driving with a trailer it is even more important that you never lug the engine. Always be in a gear that will allow you to accelerate cleanly and without chain or driveline snatch at all times.

Just as you learned to remember to maintain your distance from the curb when you first installed your sidecar, so you must learn where your trailer is, especially if it is mounted directly behind your bike. You must move over to the right so that it does not contact oncoming traffic, but more likely you will forget its width when driving at slow speeds in cramped quarters such as at a campground or parking lot.

Make sure your mirrors are now suitable for the task and that you can see around the added bulk behind you. If not, get extensions but be aware that the longer arms tend to vibrate more. A vibrating mirror is worse than no mirror.

## GROUP RIDING

Riding in groups, unless properly sponsored and supervised, can interfere with other road users. If many sidecarlists wish to travel together from Point A to Point B, they should split up into groups of no more than four or five. Motorcycle-sidecar outfits cannot split traffic and must stay within traffic lanes. Their width prevents them from riding two abreast, or even in a staggered formation as solo riders can.

A responsible leader should be appointed to keep the group together. He must give signals well in advance of intended changes, so the group can follow.

Inexperienced riders should follow the leader, while an experienced rear guard keeps tabs on those ahead. The group should follow the pace of the rear guard and not try to play "catch up" with the leader.

The group should stay together in close formation while maintaining the two-second rule. If it is necessary to pass another road user who is not a member of the group, it should be done by only one member of the group at a time.

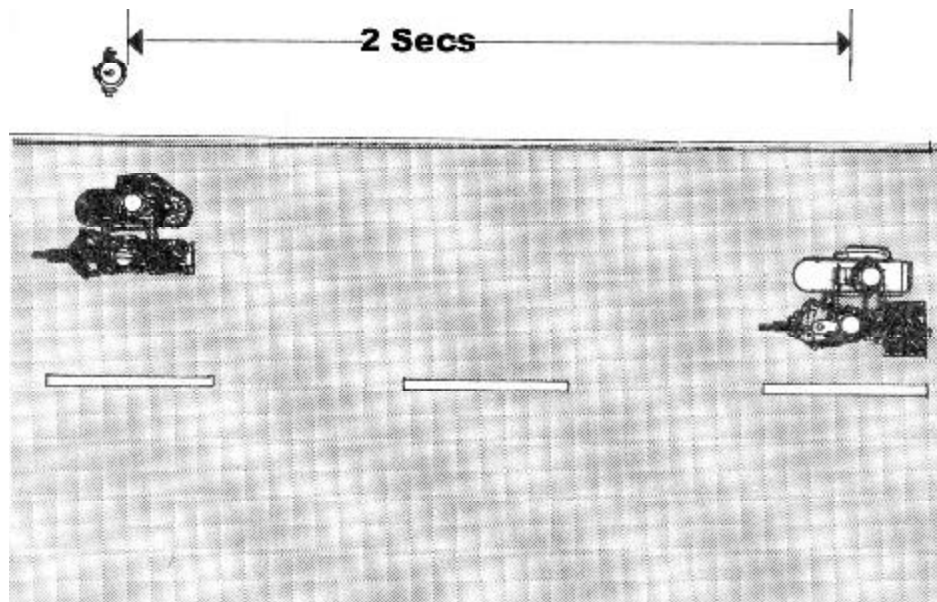

Follow the 2 Second Rule when Riding in a Group

## OPERATOR PHYSICAL/MENTAL CONDITION

Riding a motorcycle-sidecar outfit is not demanding as long as you are in normal good health. Active sidecarists include men and women over eighty years old. They even include quadriplegics who operate their sidecar outfit while sitting in a wheelchair in the sidecar, with special controls attached to the sidecar to operate the motorcycle. The operator should stay fresh and alert to cope with traffic situations.

Foremost in reducing alertness is alcohol. Do not drink and drive. Alcohol affects your judgement, vision, and timing.

Do not take any other drugs that may affect your riding skills. This includes prescription drugs. Check with your physician or druggist on possible side effects.

Stop if you feel weak or dizzy. Continue if you must at a slower pace, allowing more distance between you and other road users to compensate for your slower reaction time.

Do not drive long distances without taking plenty of breaks. Protect yourself from the elements. This includes use of the correct type of protective clothing for the conditions anticipated.

Do not cover any more distance than you feel comfortable in doing. For some, this may be 150 miles a day - for others, 300, or perhaps more.

## MOTORCYCLE/SIDECAR OUTFIT

There are plenty of things on the highway to cause you trouble. Your outfit should not be one of them. Make sure your outfit is properly equipped and maintained.

Do not add any accessories that make it harder to manage.

### The Necessary Basic Equipment

When adding a sidecar to a motorcycle you can expect a drop in performance to that of the next smaller size of solo machine. Sidecars have been added to all types of two-wheeled vehicles from motor-scooters and mopeds to 1300cc motorcycles! Generally, the addition of a sidecar to a motorcycle of less than 250cc is not recommended, motor-scooters excepted. Even a beginner should be able to handle a sidecar outfit of 350 to 400cc, equivalent to a 250cc solo machine.

With a sidecar outfit you are not concerned with balance or the ability of your feet to touch the ground as you would be for a solo machine. It is more important that whatever machine you select should feel right to you.

Most States do not have any special requirements for a motorcycle-sidecar outfit except those that pertain to the motorcycle itself.

## 14. Motorcycle/Sidecar Outfit

### Generally Requirements:

- \* A headlight and a tail light
- ^ Front and rear brakes
- \* Turn signals (some States optional)
- \* Horn
- \* Rear view mirror (left and right)
- \* A seat and footpegs for a passenger on the motorcycle
- \* In some states, the passenger must be secured by a seat belt.

All must be functional and working.

In addition, whether or not required by law, it is recommended that a rear view mirror be installed on both sides of the operator; that running lights be installed on the sidecar; and that turn signals, if fitted, be relocated so that one set is on the outside of the sidecar, the other set remaining on the opposite side of the motorcycle. Again, if fitted, all must be functional and operational. Reflectors and reflectorized tape should also be added as appropriate.

### Sidecar Care

Your sidecar outfit should always be maintained in good condition at all times. In addition to the normal safety checks each time you ride, you should also make the following checks, periodically or weekly:

## SIDECAR OPERATOR MANUAL

- (1) Check tires for tread wear. If the wear is uneven, your outfit may not be correctly aligned. A rear tire can become totally worn-out in less than 1000 miles if the sidecar is badly misaligned. Also check for cuts or cracks that could result in a blowout. Pressure should be maintained at the manufacturer's recommended upper limit.
- (2) Check wheels for missing or loose spokes, and the wheel rim for out-of-roundness and wobble. Check for worn or loose wheel bearings. Front wheel wobble can be caused by the tire or wheel being out of round or out of balance. Sidecar operation puts considerably more strain on wheels and spokes than does solo operation.
- (3) Check steering braces and steering damper.
- (4) Check and lubricate all controls, cables, and linkages. All controls should function smoothly. All cables should be free of kinks or broken strands.
- (5) Lubricate the chain and check for correct tension. Adjust if necessary. Be sure rear sprocket is in correct alignment with the front sprocket. Check sprocket for abnormal wear.
- (6) Check shock absorbers for action. If they bottom out or leak, they should be adjusted, rebuilt, or replaced.
- (7) Check all motorcycle and sidecar fasteners and parts for loose or missing nuts, bolts, or pins. Motorcycles are subject to severe vibration which shakes and breaks things off.

## 14. Motorcycle/Sidecar Outfit

- (7) Check brakes for proper action. Check for hydraulic fluid level and condition, also for leakage of hydraulic lines and their condition. The brakes should be capable of locking, if non-ABS, and not scrape. If the wheel cannot be made to lock, or if there is a scraping sound, investigate the cause and correct it.

## SIDECAR OPERATOR SKILL TEST

Safe sidecar skills are neither tested nor evaluated on regular solo motorcycle skill tests. The following covers pertinent skills needed by the sidecarist.

The applicant should be equipped with normal protective clothing that includes an approved helmet, riding clothes, and boots.

Tests should include:

### Starting On A Hill

Ride a short distance on a hill. Stop. Start. Ride in first gear on the hill. Points will be lost if :

- (a) The engine stalls or cannot be kept running after it has been stopped to begin the test.
- (b) The motorcycle is allowed to roll back while starting, or while attempting to move forward, as long as this does get out of control.

Note:

- (a) Many motorcycles are now equipped with only an electric starter. How the engine is started should not be an issue.
- (b) Use of feet should not be an issue. Except - get the feet off the ground and onto the foot rests/pegs, especially the right foot.

No balance problems are involved.

## 15. Sidecar Operator Skill Test

### Sharp Turn, Turning, and Stopping

Begin from a stop and make a sharp right turn. Continue turning right, and speed up to 15 mph.

Shift to second gear. Turn left, and come back on the same curve at 15 mph. Make a gradual stop with the front tire between two lines.

On the sharp turn, points are lost if you:

- (a) Ride outside the curve.

While turning right or left, you lose points if you:

- (a) Ride outside the curve.
- (b) Ride too slow.

While stopping you can lose points if you:

- (a) Skid the wheels.
- (b) Miss the stop lines.

### Turning Speed Judgment

In this test you will ride around a curve at your own safe maximum speed.

You lose points if you:

- (a) Ride too slow.
- (b) Ride outside the curve.

### Quick Stop - Straight

Ride at 15 mph. Stop as quickly as possible when the signal is given, using both brakes.

Your lose points if you:

- (a) Ride too slow.
- (b) Take too long to stop.
- (c) Swerve to the left.

### Quick Turn

Ride at 15 mph, then turn quickly around a 7-foot-wide barrier, turning either left or right according to the signal.

Once around the barrier turn back the other way.

Your lose points if you:

- (a) Ride too slow.
- (b) Turn the wrong way.
- (c) Ride over the barrier.

### Stopping the Test

The examiner will stop the test if you disregard instructions, or if you loose sufficient points that would cause you to fail, or if you, in the opinion of the instructor, exhibit a wanton disregard for safe driving habits.

You may also stop the test at any time if you feel uncomfortable or do not feel confident to proceed. Practice, then retake the test later.



*Find motorcycle sidecar FAQ's, news, guides, articles, photo galleries, message boards, pricing information and more on the web at [CycleSidecar.com](http://CycleSidecar.com)!*